



Market Manual 1: Connecting to Ontario's Power System

Part 1.6: Performance Validation

Issue 15.0

A document to mitigate risks that equipment will not be suitable for connection to the IESO-controlled grid and to clarify validation requirements.

Disclaimer

The posting of documents on this website is done for the convenience of *market participants* and other interested visitors to the *IESO* website. Please be advised that, while the *IESO* attempts to have all posted documents conform to the original, changes can result from the original, including changes resulting from the programs used to format the documents for posting on the website as well as from the programs used by the viewer to download and read the documents. The *IESO* makes no representation or warranty, express or implied that the documents on this website are exact reproductions of the original documents listed. In addition, the documents and information posted on this website are subject to change. The *IESO* may revise, withdraw or make final these materials at any time at its sole discretion without further notice. It is solely your responsibility to ensure that you are using up-to-date documents and information.

This *market manual* may contain a summary of a particular *market rule*. Where provided, the summary has been used because of the length of the *market rule* itself. The reader should be aware however, that where a *market rule* is applicable, the obligation that needs to be met is as stated in the *market rules*. To the extent of any discrepancy or inconsistency between the provisions of a particular *market rule* and the summary, the provision of the *market rule* shall govern.

Document ID	IESO_REQ_0208
Document Name	Part 1.6: Performance Validation
Issue	Issue 15.0
Reason for Issue	Issue released in advance of Baseline 48.1
Effective Date	October 14, 2022

Document Change History

Issue	Reason for Issue	Date
-	For changes prior to 2016, refer to versions 9.0 and prior	-
5.0	<p>Updated Section 3.2 Recognition of Inherent Limitation with respect to primary frequency response requirements from wind generators.</p> <p>Added Figure 5 to illustrate the frequency response requirements from wind generators.</p> <p>Updated the List of Acceptable Compensator Dynamic Models in Section 5.7.</p> <p>Updated the List of Acceptable Wind Turbine and Photovoltaic Dynamic Models in Section 5.7 with the WECC second generation standard models.</p>	June 1, 2016
6.0	<p>Added Section 2.5 Re-validation Testing and Reporting</p> <p>Updated the List of Acceptable Compensator Dynamic Models in Section 5.7.</p>	December 7, 2016
7.0	<p>Added GENTPJ to list of acceptable models.</p> <p>Reference to PRC-019 and PRC-024 added in §5.</p> <p>Minor syntax improvements throughout the document.</p>	June 7, 2017
8.0	Section 5.7: Added DC4B to the list of Excitation System Models.	June 5, 2019
9.0	Section 5.5 Table 2- Updated: T'do from 2.0 to 6.0 for both GENSAL and GENROU models.	September 11, 2019
10.0	<p>Section 5.7 Updated Wind Turbine and Photovoltaic Acceptable Dynamic Model names to reflect PSSE and DSA nomenclature.</p> <p>Section 2.3 Updated to make distinction between a new installation and existing equipment swap between units.</p> <p>Added LST-48 to Related Documents Table.</p>	October 4, 2019
11.0	<p>Issue released in advance of Baseline 44.0.</p> <p>This market manual has been moved to the new Market Manual 1: Connecting to Ontario's Power System series and the document part number has changed from 2.20 to 1.6.</p>	June 29, 2020
12.0	Update the Market Manual to reflect the updates to Market Rule Appendices 4.2 and 4.3. In addition, update the list of acceptable dynamic model to meet the <i>NERC</i> list.	December 2, 2020
13.0	Issue released in advance of Baseline 45.0. Updated to include electricity storage participation.	February 26, 2021
14.0	Issue released for Baseline 45.1. Updated to include <i>generation unit</i> and <i>electricity storage unit</i> information.	June 2, 2021

Issue	Reason for Issue	Date
15.0	Issue released in advance of Baseline 48.1	October 14, 2022

Related Documents

Document ID	Document Title
MDP_PRO_0048	Market Manual 1.4: Connection Assessments
PRO-408	Market Manual 1.5: Market Registration Procedures
LST-48	Register Facility Help File

Table of Contents

Table of Contents	i
List of Figures	iii
List of Tables	iv
Table of Changes	v
Market Manual	1
Market Procedures	1
1. Purpose	2
1.1 Purpose.....	2
1.2 Scope.....	2
1.3 Who Should Use This Manual	3
1.4 Conventions	3
2. General Requirements	4
2.1 Managing Changes to Performance Standards.....	4
2.2 Meet Prevailing or Maintain Existing.....	5
2.3 Outage Slip or Connection Assessment	6
2.4 Demonstrating Performance	6
2.5 Re-validation Testing and Reporting.....	7
2.6 Equivalent Machine.....	7
2.7 Dynamic Disturbance Recorder (DDR).....	7
3. Requirements for Generation and Electricity Storage Facilities	9
3.1 Off-Nominal Frequency Operation	9
3.2 Speed/Frequency Regulation	10
3.3 Ride Through	14
3.4 Active Power	19
3.5 Reactive Power.....	21

3.6	Automatic Voltage Regulator (AVR)	23
3.7	Excitation System	25
3.8	Power System Stabilizer (PSS)	26
3.9	Phase Unbalance.....	27
3.10	Armature and Field Limiters	28
3.11	Technical Characteristics	30
3.12	Reactive Power Response for Inverter-Based Units.....	30
3.13	Electricity Storage	31
4.	Validation of Other Elements	32
4.1	General	32
4.2	Switches and Breakers	32
4.3	Transmission Circuits.....	32
4.4	Series Compensation.....	32
4.5	Shunt Compensation	33
4.6	Transformers.....	33
4.7	Synchronous Condensers and Static var Compensators (SVC)	33
4.8	Protection Systems	33
4.9	Special Protection Systems (SPS).....	33
5.	Testing, Reporting, and Modelling	39
5.1	Conventional Generation and Non-Inverter Based Electricity Storage Facilities Reporting Requirements	39
5.2	Non-Conventional Generation and Inverter-Based Electricity Storage Facilities Reporting Requirements	41
5.3	Summary of Generation and Electricity Storage Facilities Considerations and Tests	43
5.4	Summary of Other Equipment Considerations and Tests.....	44
5.5	Default Modelling	45
5.6	Acceptable Dynamic Models.....	46
5.7	Abbreviations and Acronyms	49

List of Figures

Figure 1 - Equipment Performance Requirement Evolution	4
Figure 2 - Dynamic Disturbance Recorder Inputs	8
Figure 3 - Off-Nominal Frequency No-Trip Requirement	9
Figure 4 - Active Power Speed and Magnitude of Response Requirement	11
Figure 5 - Primary Frequency Response Requirement	13
Figure 6 – NERC PRC-024 Voltage Ride Through Requirement	16
Figure 7 - Single-Line Diagram of No-Tripping for Out-of-Zone Faults Requirement	17
Figure 8 - Example Current Waveform for Showing Fault Clearing Times	18
Figure 9 - Positive Sequence Voltage During a Fault	18
Figure 10 - Reactive Power Requirement at all Levels of Active Power	20
Figure 11 - Reactive Power Priority	20
Figure 12 - Fixed Admittance Capacitors Compensating Losses Within Generation Facilities ..	21
Figure 13 - Regulation with Individual Units at Limit	22
Figure 14 - Voltage Control Point	23
Figure 15 - Example of Configuration Which Requires Two AVR Voltage Sources	24
Figure 16 - Excitation System Ceiling Requirements	25
Figure 17 - Power System Stabilizer Phase Compensation Margin	26
Figure 18 - Temporary Field Current Requirements	28
Figure 19 - Capability Curve	29
Figure 20 – Acceptable vs unacceptable reactive power response of Inverter-based units	31
Figure 21 - Contingency Detection Logic	34
Figure 22 - Breaker Trip Module	35
Figure 23 - Generation Rejection	36
Figure 24 - Generation Runback	37
Figure 25 - Protection Timing	38
Figure 26 - Active Power Participation Justified by Performance	42

List of Tables

Table 1 - Default Power Flow and Dynamics Parameters	45
Table 2 - Default Machine Parameters	45
Table 3 - Default AVR/Exciter Parameters	45
Table 4 - Default PSS Parameters.....	45

Archive

Table of Changes

Reference (Section and Paragraph)	Description of Change
Section 5.6	Added HYG0VD and H6E1 to the list of acceptable Turbine/Governor Models.

Archive

Market Manual

The *Market Manuals* consolidate the market procedures and associated forms, standards and policies that define the operation of the various areas within the *IESO-administered markets*. Market procedures provide more detailed descriptions of the requirements for various activities than are specified in the *Market Rules*. Where there is a discrepancy between the requirements in a document within a *Market Manual* and the *Market Rules*, the *Market Rules* shall prevail. Standards and policies appended to, or referenced in, these procedures provide a supporting framework.

Market Procedures

“Connecting to Ontario's Power System” is Series 1 of the Market Manuals, where this document forms Part 1.6: Performance Validation.

- End of Section -

1. Purpose

The primary object of the *Performance Validation* manual is to mitigate risks that equipment will not be suitable for connection to the *IESO-controlled grid*. A secondary object is to clarify the scope and nature of activities that shall be performed by *Market Participants* to balance a conditional right to connect to the *IESO-controlled grid* granted at the end of the connection assessment process with an obligation to demonstrate equipment performance required during the market entry process. *IESO* requires an acceptable level of confidence that models for power system equipment are suitable for its planning and operating decisions. Performance validation achieves this level of confidence.

1.1 Purpose

Market Manual 1.6: Performance Validation is the third of three *market manuals* that cover the [Connecting to Ontario's Power System](#) process. The Connecting to Ontario's Power System process consists of six (6) stages, which are described in the following *market manuals*:

Stage	Market Manual
1. Prepare application 2. Obtain conditional approval to connect	Part 1.4: Connection Assessment and Approval (formerly Market Manual 2.10)
3. Design and build	N/A ¹
4. Authorize market and program participation 5. Register equipment	Part 1.5: Market Registration Procedures
6. Commission equipment and validate performance	Part 1.5: Market Registration Procedures, and Part 1.6: Performance Validation (formerly Market Manual 2.20)

This *market manual* contains the procedures related to performance validation, which encompasses Stages 6 of the process, and is a guide to mitigate risks that equipment will not be suitable for connection to the *IESO-controlled grid* and to clarify validation requirements.

1.2 Scope

This *Performance Validation* manual describes how equipment will be treated as performance standards evolve, when performance validation is required, what an acceptable validation comprises, and other topics related to equipment performance.

¹ The “Stage 3: Design and build” activities are determined between the connection *applicant* and its associated *transmitter* or *distributor* after the completion of Stages 1 and 2.

This *Performance Validation* manual describes performance requirements and validation procedures for common components of the *IESO-controlled grid* with more attention devoted to *generating units* and *electricity storage units*. Modelling, testing, and reporting considerations are presented in Section 5.

1.3 Who Should Use This Manual

The *Performance Validation* manual is for external use by those contemplating connections to the *IESO-controlled grid* (ICG) and for internal use by *IESO* staff.

1.4 Conventions

The standard conventions followed for market manuals are as follows:

- The word ‘shall’ denotes a mandatory requirement;
- Terms and acronyms used in this market manual including all parts thereto that are italicized have the meanings ascribed thereto in Chapter 11 of the “Market Rules”; and
- Double quotation marks are used to indicate titles of legislation, publications, forms, and other documents.

Any procedure-specific convention(s) shall be identified within the procedure document itself.

- End of Section -

2. General Requirements

2.1 Managing Changes to Performance Standards

In general, new equipment or major changes to existing equipment must meet prevailing requirements while maintenance and minor changes must preserve existing capability.

As it is impracticable to change equipment each time “Market Rules” equipment performance requirements are updated, an orderly process to evolve equipment performance is necessary. Persistent performance changes after market entry are anticipated only in association with a new connection assessment. These concepts are illustrated below.

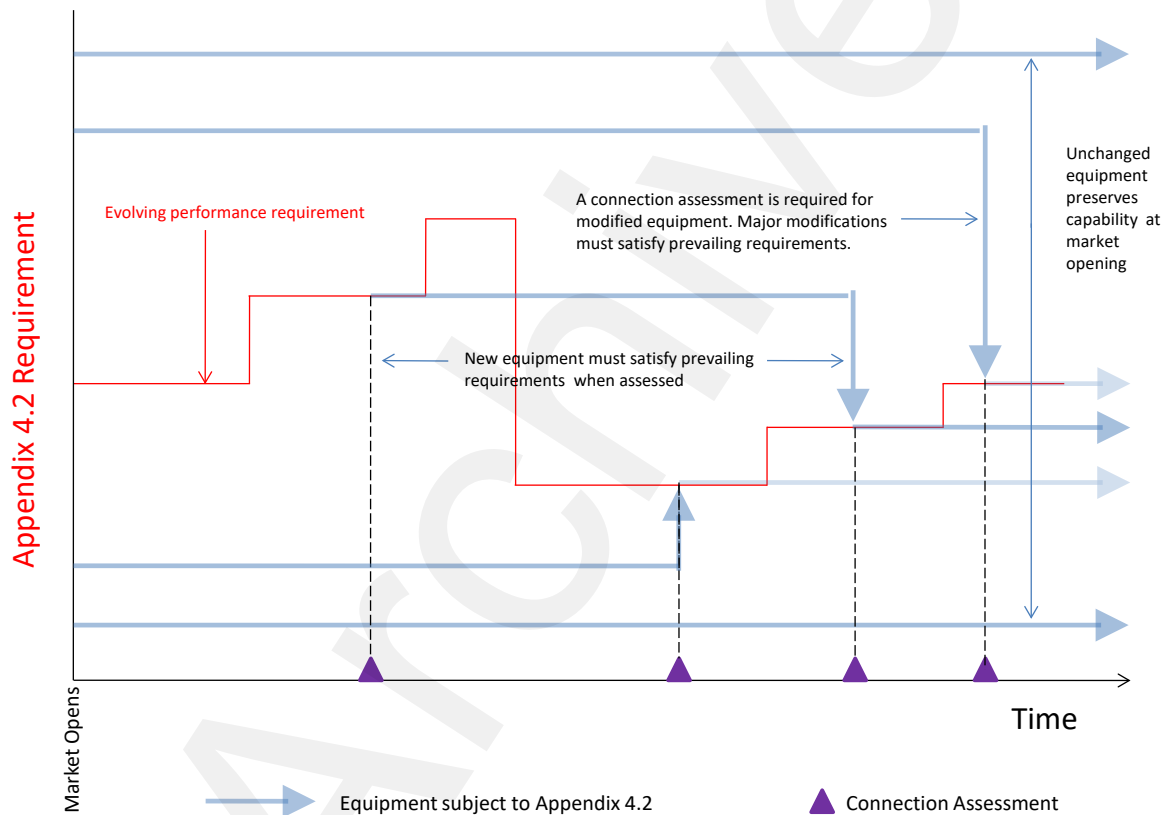

Figure 1 - Equipment Performance Requirement Evolution

To assist compliance verification, *IESO* will document the prevailing performance requirements at the time of equipment connection.

2.2 Meet Prevailing or Maintain Existing

A ‘major’ change must meet prevailing “Market Rule” requirements. Other changes, such as using like-for-like spares for unplanned equipment failures, must at a minimum maintain existing performance previously approved for connection. The *IESO* should be consulted when in doubt if a change is ‘major’.

A ‘major’ change is a planned replacement or modification of the output stage of an associated system. For guidance, replacing example minor system components in the table below would not trigger an obligation to meet prevailing requirements while replacing example major system components are ‘major’ changes that would trigger this obligation.

System	Rotating Exciter	Static Exciter	Governor	Inverter- Based Resources (Including DERs)
Minor System Components	AVR	AVR or PSS or both	Speed Regulator	Plant Controller
	Pilot Exciter or Amplidyne	Bridge or Exc. Transformer		
Major System Components	Main Exciter	Bridge and Exc. Transformer	Turbine-control mechanism	Main Inverter

Replacing the AVR or pilot exciter or both in a rotating system would not trigger a need to meet the prevailing requirements as neither of these are major components. Replacing the main exciter in a brushless system would not trigger the need to meet the prevailing requirements unless the main generator field connections were accessible. For units with accessible slip rings, changing the main exciter would trigger a need to meet prevailing standards. For static systems, changing both the excitation transformer and the bridge would trigger an obligation to meet prevailing standards, but changing either the excitation transformer or the bridge would not trigger this obligation.

It is not acceptable to split the replacement of a major component into a series of minor component replacements to escape performance requirements in the prevailing standard. The provision to allow for the replacements with spares is not intended to allow some equipment to perpetually remain below a higher prevailing performance standard. When an asset owner decides equipment has reached the end of its normal design life, replacements must satisfy prevailing performance standards.

Non-major replacements should not inhibit the capability to satisfy a prevailing standard to the extent practicable. For example, a replacement excitation system transformer should be not only able to function with the existing bridge but also not preclude meeting prevailing requirements (e.g. required positive and negative ceiling voltages) when the bridge is replaced if this transformer will be retained.

Performance from an existing spare must maintain existing capability. A spare must satisfy prevailing requirements at the time of its purchase. For example, replacing a failed dc exciter with an existing spare is acceptable provided other parameters are unaltered (e.g. AVR settings). In cases of

like-for-like replacements, testing can be limited in scope (e.g. open circuit tests, steady state field current measurements, etc.) to confirm there will be no material changes in performance.

2.3 Outage Slip or Connection Assessment

Maintenance work and short duration de-ratings fall under the regime of the *IESO* outage management process not the connection assessment process.

New or modified equipment must pass through both the *IESO* connection assessment and market entry processes before connection to the *IESO-controlled grid*. With ‘maintenance’ work there is no reasonable expectation of change to performance characteristics reported to the *IESO*. Activities at either end of the spectrum are easy to categorize. Replacing a wiped bearing requires an outage slip while installing a new exciter requires a connection assessment. Swapping existing like-for-like exciters between units requires an outage slip and tests that confirm to the *IESO* that performance characteristics are unchanged. When there is a reasonable expectation that performance characteristics reported to the *IESO* have changed, then an application to the *IESO* connection assessment process is required. Like-for-like applications are streamed into an expedited process for improved efficiency.

2.4 Demonstrating Performance

Verified equipment performance characteristics are often not available until after a connection assessment application is submitted to the *IESO*. Delays may arise when measured performance is less than predicted in the connection assessment process as re-assessments take time. Often it may be more efficient to begin by assuming default characteristics that marginally satisfy performance requirements. If *IESO* studies show this performance is good enough, then no further action is required by the proponent related to modelling during the Connection Assessment process. When this approach would lead to connections restrictions; a proponent should be consulted to determine the most practicable path forward. Default characteristics are presented in Section 5.5.

Performance that cannot be validated by a proponent during the Market Entry process will not be assumed to meet requirements for connection. Equipment often must be connected to the *ICG* to complete performance validation. Equipment will not be connected until *IESO* accepts the scope of validation testing and permission to remain connected depends on successful demonstration of required performance. Testing will be completed within two months of connection.

An acceptable validation will generally comprise measurements that closely match simulation predictions using the models provided. Measured outcomes and simulation results are required to be expressed in a manner that facilitates comparison by overlying simulations results with measured outcomes for a given test. In some cases, (e.g. underfrequency trip settings) it will be sufficient to report a setting and demonstrate that it satisfies the requirement. Testing to demonstrate reliable performance should be as realistic as reasonably achievable. For example, manually changing from “AUTO” to “MANUAL” is not as good a bumpless transfer test as pulling the PT fuse as the former is not a true end-to-end test. Testing conditions must be tailored to mitigate adverse effects of unexpected or substandard performance.

The *Market Participant* is responsible for making provisions to test equipment in a safe and controlled manner. For example, setpoint changes are often ramped rather than stepped during usual

operation. Ramping can interfere with conclusively demonstrating dynamics requirements have been satisfied. If a step change is necessary to demonstrate performance, the *Market Participant* will be responsible for enabling this step change.

Simulation results from detailed models cannot be put forward as validation of models provided for IESO studies. Measurements are required by *IESO* to validate performance.

Type tests performed in accordance with recognized standards may reduce the scope of validation testing. Type tests are especially useful for validating parameters that represent inherent characteristics (e.g. inertia) or properties onerous to test (e.g. ride-through). Some care should be taken to avoid confusing vendor acceptance tests with type tests. Type tests are performed by an accredited and independent testing agency to widely accepted industry standards.

It may be impracticable to guarantee that all elements of a facility, especially those elements not subject to modification, satisfy all *IESO* performance requirements. It is sufficient for a Market Participant to confirm there are no known performance issues and to commit to resolving performance issues as they become known.

2.5 Re-validation Testing and Reporting

Steady state and dynamic capability of generating units, electricity storage units, synchronous condensers, STATCOMS, and SVCS must be validated on a periodic basis or following modifications that affect capability. The IESO will use *NERC MOD* standards (MOD-025, MOD-026, and MOD-027) requirements as a guide to identify performance requirements. Steady state capability must be re-validated at least every five years. Dynamic capability must be re-validated at least every ten years.

IESO shall post details concerning re-validation testing and reporting on its public website.

2.6 Equivalent Machine

The “Market Rules” tendency to express performance requirements at a transmission connection point is intended to cater for all types of generation and electricity storage technologies. Many aspects of conventional units are either not present or present in a very different form in non-conventional facilities. For example, a 100 MVA hydro-electric unit will have a single terminal where voltage is regulated while a 100 MVA wind generation facility will have many unit terminals and none of these terminals may be a suitable voltage regulation point.

Voltage, active power, and reactive power performance at the connection point for non-conventional technologies is required to be consistent with that of an equivalent synchronous machine with characteristic parameters within typical ranges. In the example above, the multiple-unit wind generation facility will be expected to provide the same voltage support at the connection point as the single-unit hydro-electric generation facility.

2.7 Dynamic Disturbance Recorder (DDR)

A permanent dynamic disturbance recorder must be installed to provide the capability to demonstrate equipment continues to meet dynamic performance requirements during and after commissioning

tests. Measurements must be synchronized to within 2 milliseconds or less of Universal Coordinated Time scale (UTC). Sampling rates, triggering methods, monitoring selections and reporting format (e.g. COMTRADE) must be accepted by the IESO prior to its authorization to energize the main output transformer.

The figure below illustrates the primary voltage and current locations for inputs to the DDR must not be separated by material impedance. In this figure, blue lines correspond to a set of CT and PT inputs on the high voltage side of the main output transformer and red lines on the low voltage side. Additional inputs, as shown by grey lines, can be useful to identify the source of performance problems.

The DDR must be capable of recording two sets of channels with the following sampling rates:

- 1) High speed channels with a capability to store at least 1 second of instantaneous values of the three phase voltages and currents at a minimum sampling rate of 100 samples per cycle.
- 2) Low speed channels with the capability to store at least 30 seconds of frequency, positive sequence voltage, positive sequence current, 3-phase active power, and 3-phase reactive power at a minimum sampling rate of 1 sample per cycle.

The DDR triggering methods are location sensitive and hence they will be communicated on a project-by-project basis during the IESO's market entry process. Typical triggers are low frequency, low positive sequence voltage and high rate of change of active and reactive power. High/low speed channels are typically configured to record 200 ms/5 s before a triggering event. DDR records must be available upon IESO request.

One example of a dynamic disturbance recorder that meets all IESO requirements is the Tesla 4000 by ERL Phase.

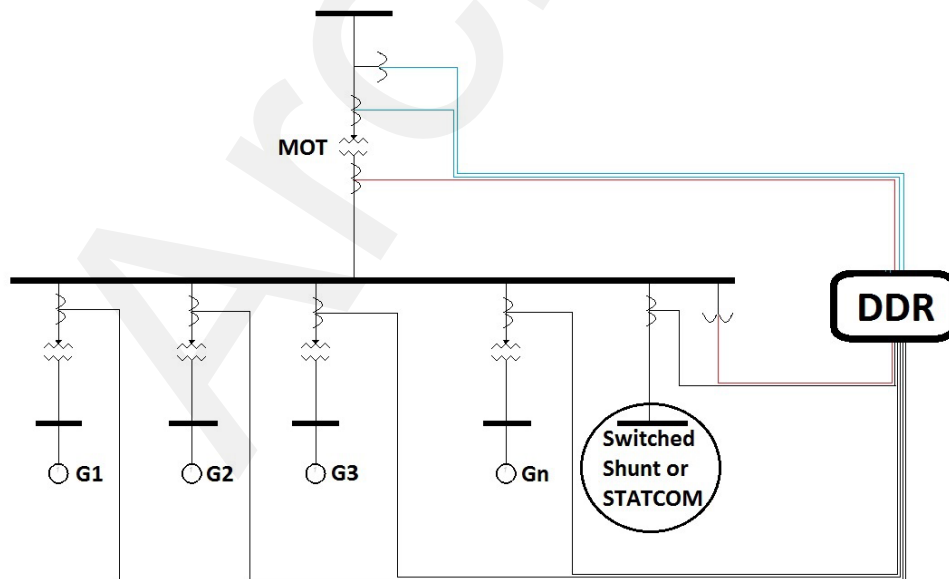

Figure 2 - Dynamic Disturbance Recorder Inputs

- End of Section -

3. Requirements for Generation and Electricity Storage Facilities

The next subsections discuss each technical requirement for *generation facilities* and *electricity storage facilities* to mitigate the risk that equipment will not be suitable for connection. The Table in Section 5.3 summarizes anticipated tests. Generation models acceptable to IESO are listed in Section 5.6.

3.1 Off-Nominal Frequency Operation

1. Off-Nominal Frequency Operation	Operate continuously between 59.4 Hz and 60.6 Hz and for a limited period of time in the region bounded by straight lines on a log-linear scale defined by the points (0.0 s, 57.0 Hz), (3.3 s, 57.0 Hz), and (300 s, 59.0 Hz) and the straight lines on the log-linear scale defined by the points (0.0 s, 61.8 Hz), (8 s, 61.8 Hz), and (600 s, 60.6 Hz).
------------------------------------	---

This is a requirement not to trip within a defined frequency-time area and it should not be misinterpreted as a requirement to trip outside of this region. IESO does not have either an underfrequency trip or overfrequency trip requirement and it discourages unnecessary or premature equipment tripping for any reason. As shown in Figure 3, the area outside of the frequency ride-through “No Trip” zones should not be interpreted as a “Must Trip” zone, and should be considered as a “May Trip” zone. Tripping should be based on physical equipment limitations or specifications. Protection functions should be set as wide as possible while ensuring equipment safety and reliability.

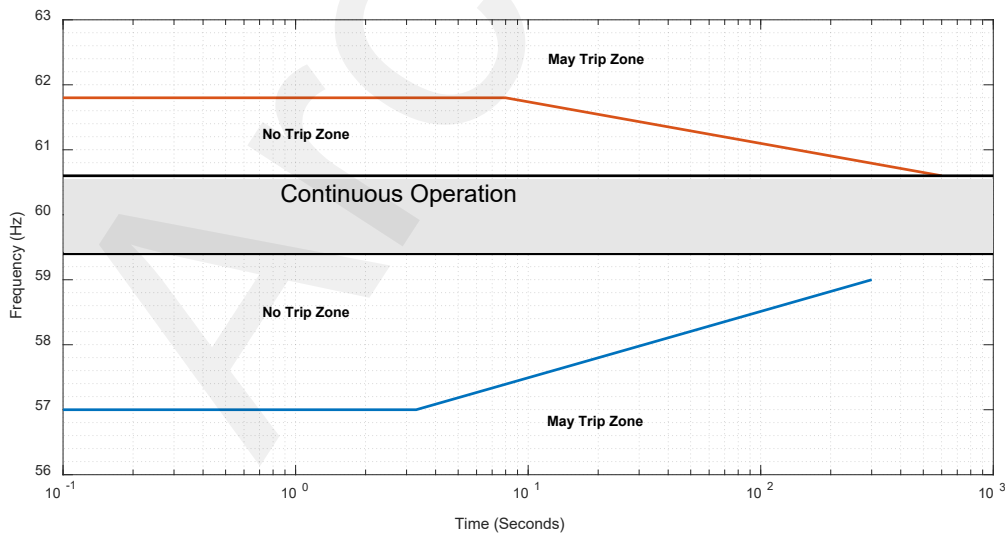

Figure 3 - Off-Nominal Frequency No-Trip Requirement

Essential auxiliary functions also must not trip within this frequency-time region. Generators and *electricity storage participants* have discretion to select the number of frequency-time pairs to define a tripping requirement but no pair can be within the forbidden region. *Generation units* and *electricity*

storage units can be manually disconnected after consultation with the IESO operators if the frequency does not recover above 59.4 Hz after 300 seconds.

Tripping based on instantaneous frequency calculations is not permitted. Inverter-based generation and *electricity storage units* shall calculate the fundamental frequency over a time window of 3 to 6 cycles and filter for spikes caused by phase jumps due to disturbances and routine switching events.

3.2 Speed/Frequency Regulation

2. Speed/Frequency Regulation	Regulate speed/frequency with an average droop based on maximum active power adjustable between 3% and 7% and set at 4% unless otherwise specified by the <i>IESO</i> . Regulation deadband shall not be wider than $\pm 0.06\%$. Speed/frequency shall be controlled in a stable fashion in both interconnected and island operation. A sustained 9% change of applicable rated active power as defined in category 4 after 10 s in response to a step change of speed of 0.5% during interconnected operation shall be achievable. Due consideration will be given to inherent limitations such as mill points and gate limits when evaluating active power changes. Control systems that inhibit primary frequency response shall not be enabled without <i>IESO</i> approval.
-------------------------------	--

Droop

Droop will be calculated on a *generation facility* or *electricity storage facility* basis. For a combined-cycle facility, the droop for the gas units will be required to compensate to the extent practicable for steam units. Reducing unit droop below 3% to achieve an overall facility droop of 4% will not be required by *IESO*.

Some types of generation (e.g. hydro-electric) may require different governor control settings to achieve both a rapid response during interconnected operation and a stable response during island operation. The switch between these two settings must be automatically triggered by conditions that are subject to *IESO* approval. Normally either frequency alone or a combination of frequency and rate of change of frequency would be an acceptable trigger to switch to island settings. Where a recognized contingency would establish an island, this automatic switch should take place for frequency deviations larger than required to initiate the first step of automatic underfrequency load shedding (i.e. 59.3 Hz). Where an extreme contingency would be required to establish an island, this automatic switch should take place for frequency deviations larger than the frequency declines (i.e. 58.0 Hz) the automatic underfrequency load shedding program is intended to limit.

Electricity storage units shall provide frequency regulation according to its droop and deadband settings at all active power levels including when it is withdrawing active power.

Speed and Magnitude of Response

The required relationship among time, speed (frequency), and active power are sketched below.

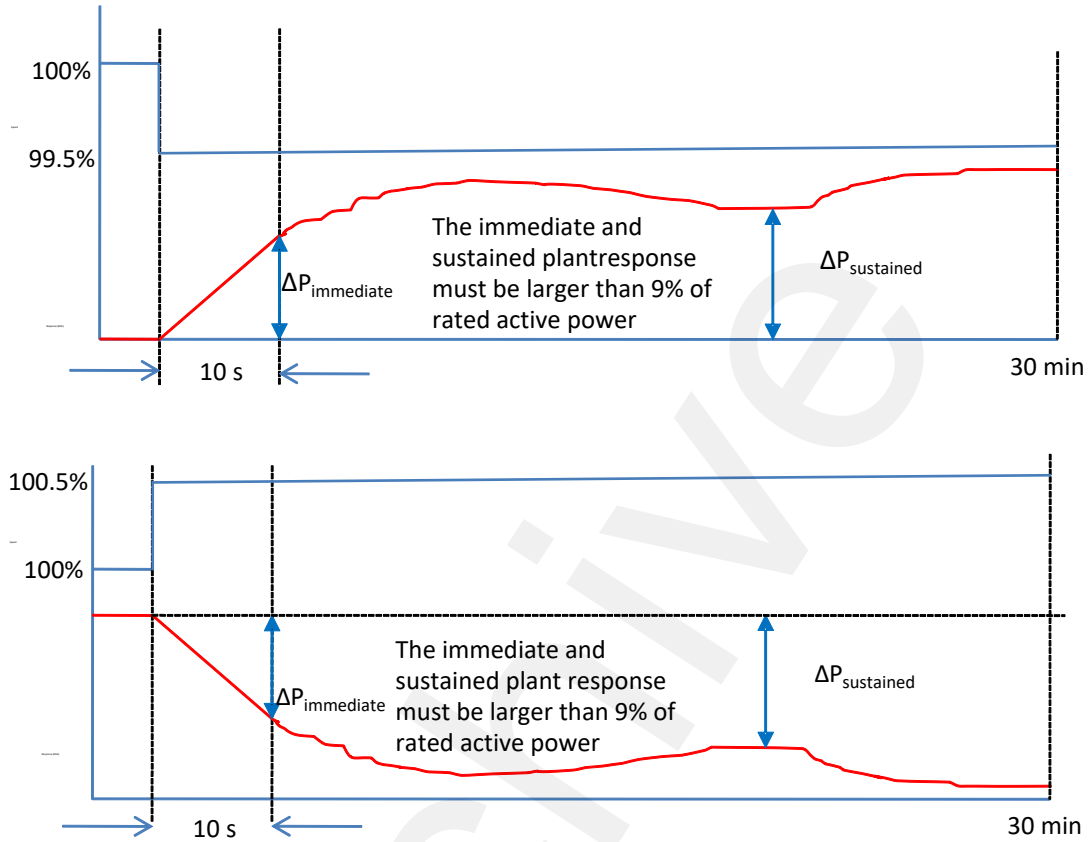

Figure 4 - Active Power Speed and Magnitude of Response Requirement

Recognition of Inherent Limitations

Units at full power will not be expected to contribute more active power when frequency declines nor will units at minimum power be expected to contribute less active power when frequency increases. When a performance feature is commercially available from a variety of vendors, then it ceases to be an inherent limitation.

As several vendors now offer the capability to use energy stored in rotating wind turbine blades to provide a temporary boost in active power; this feature is now required to help mitigate severe frequency declines. However, no capability for a sustained increase in active power for frequency declines is required from wind turbines so there is no need to continually “spill” wind.

The *IESO* will notify generators that have wind turbines with this capability when this feature must be placed in-service.

Functional requirements for this feature are as follows:

- The active power boost shall be triggered when frequency drops below 59.7 Hz.
- The boost activation time shall not exceed 1 second.
- The boost must exceed 10% of pre-trigger active power.
- The boost shall last at least 10 seconds if frequency remains under 59.964 Hz.
- The boost shall be cancelled if frequency rises above 59.964 Hz.
- The rate of energy withdrawn from the system during active power recovery must in general be less than the rate of energy injected into the system during the active power boost.
- Following activation, the boost capability shall be available again within 30 minutes.

Representative responses of a wind turbine with this feature placed in-service, consistent with the functional requirements above, are shown in Figure 5 below for two illustrative cases (corresponding to two different triggering events).

Solar generation does not now have a similar store of energy so active power increases are not yet required from solar installations, but this may change as technology evolves.

All generation types (e.g. conventional, wind, solar) must reduce active power for overfrequency excursions outside of the $\pm 0.06\%$ (i.e. 36 mHz) deadband.

Control Systems that Inhibit Primary Frequency Response

Control systems that inhibit primary frequency response shall be supported by a rationale that demonstrates performance reductions are offset by other advantages. For example, a slow outer loop control of small hydro-electric units to maximize efficiency would be permitted if interference is slight with active power response within 30 seconds following an upset. In this case, an immaterial reduction in performance to maintain reliability is offset by a greater public good.

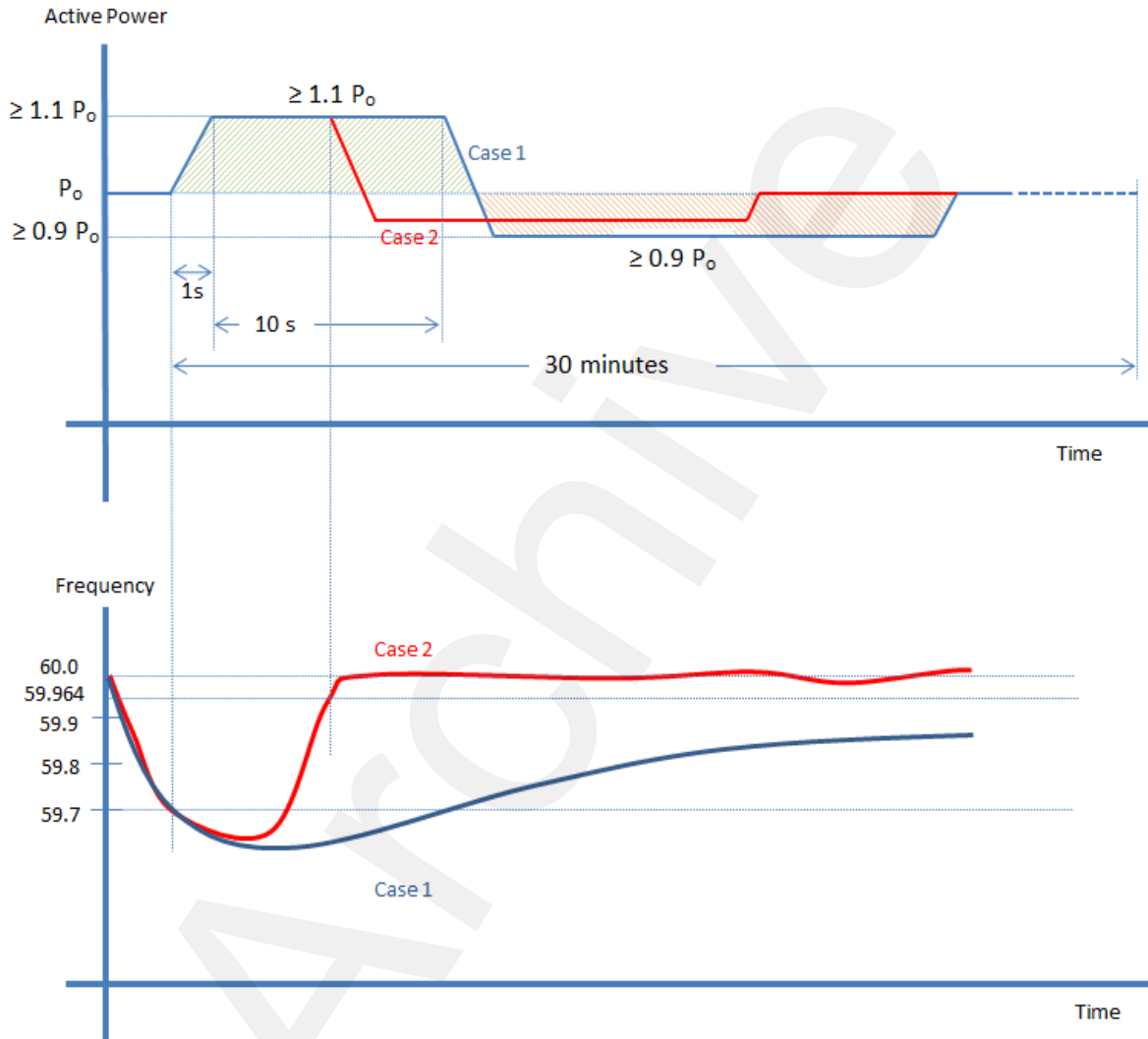

Figure 5 - Primary Frequency Response Requirement

3.3 Ride Through

3. Voltage Ride-Through	Ride through routine switching events and design criteria contingencies assuming standard fault detection, auxiliary relaying, communication, and rated breaker interrupting times unless disconnected by configuration. For Inverter-based units, momentary current cessation or reduction of output current during system disturbances is not permitted without IESO approval.
-------------------------	--

Equipment must not trip for spikes associated with routine high voltage capacitor switching, automatic reclosure, or for design criteria contingencies that do not disconnect *generation facilities* or *electricity storage facilities* by configuration. Lightning strikes on the *IESO-controlled grid* also must not result in generation or *electricity storage unit* trips unless disconnected by configuration. Minor internal upsets must also not result in equipment tripping. For example, the loss of the voltage signal following a blown PT fuse should result in a bumpless transfer to manual control rather than a trip.

Large shunt reactive elements are common at transmission stations in Ontario and the switching of these shunts must not result in equipment trips. Shunt reactors range in size up to 150 Mvar while shunt capacitor banks range in size up to 400 Mvar. The magnitude of routine switching transients is site dependent and must be considered in the facility design.

Both low and high voltage aspects of ride through will be exercised by contingencies. Tripping is not permitted either for the low voltage before fault clearing or for the high voltage spike after fault clearing. *Generation facilities* and *electricity storage facilities* must have sufficient high and low voltage ride through capability to not trip needlessly. At a minimum, generators and *electricity storage participants* must follow the ride through requirements identified in the reliability standards; i.e., *NERC PRC-024* for transmission connected generation units and *CSA C22.3 no. 9* (or *UL1741 SA* or equivalent standards but only as an interim certification until equipment compliant with *C22.3 no. 9* becomes available in Ontario) for units connected within a distribution system or a *wholesale customer*. As an example, *NERC PRC-024-2* ride through requirements diagram is shown below. More stringent requirements may be identified in the system impact assessment as a result of IESO system studies.

Generation units connected within a *connected wholesale customer's* or *distributor's* facilities or *distribution systems*, that were issued a connection impact assessment from the local distribution company ("LDC") before September 21, 2020 remain subject to the connection requirements under Category 12 of Appendix 4.3 of Chapter 4 of the *market rules* that were in place as of the date of such issuance. *Generation units* connected within a *connected wholesale customer's* or *distributor's* facilities or *distribution systems* that were issued a connection impact assessment from the LDC on or after September 21, 2020 are subject to the requirements in Category 12 of Appendix 4.3 that came into effect on such date.

Electricity storage units connected within a *connected wholesale customer's* or *distributor's* facilities or *distribution systems*, that were issued a connection impact assessment from the LDC before January 18, 2021 remain subject to the connection requirements in place under Category 12 of Appendix 4.3 as of the date of such issuance. *Electricity storage units* connected within a *connected wholesale customer's* or *distributor's* facilities or *distribution systems* that were issued a connection impact assessment from the LDC on or after January 18, 2021 are subject to the requirements in Category 12 of Appendix 4.3 that came into effect on such date.

For clarity:

1. The requirements in Category 12 of Appendix 4.3 as described in the two preceding paragraphs also apply to *generation units* or *electricity storage units* connected behind a distribution electricity meter.
2. For *generation units* or *electricity storage units* connected within a *connected wholesale customer's* or *distributor's* facilities or *distribution systems* and for which a **Micro-Embedded Generation Facility Connection Agreement** published by the *OEB* is entered, the requirements in the **Micro-Embedded Generation Facility Connection Agreement** at the time the connection impact assessment from the LDC was issued apply in place and instead of the requirements set out in Category 12 of Appendix 4.3.
3. Inverter-based *generation units* or *electricity storage units* connected within a *connected wholesale customer's* or *distributor's* facilities or *distribution systems* are permitted to have enabled momentary current cessation or reduction of output current as permitted under CSA C22.3 no. 9 (or, alternatively, as permitted under UL1741 SA or equivalent standards, but only as an interim certification until equipment compliant with C22.3 no. 9 becomes available in Ontario).
4. The requirements in Category 12 of Appendix 4.3 are deemed met if the *generation units* or *electricity storage units* connected within a *connected wholesale customer's* or *distributor's* facilities or *distribution systems* are compliant with CSA C22.3 no. 9 (or, alternatively, UL1741 SA or equivalent standards, but only as an interim certification until equipment compliant with C22.3 no. 9 becomes available in Ontario). The minimum ride-through settings are provided in Tables 12 and 14 of the CSA C22.3 no.9 standard.

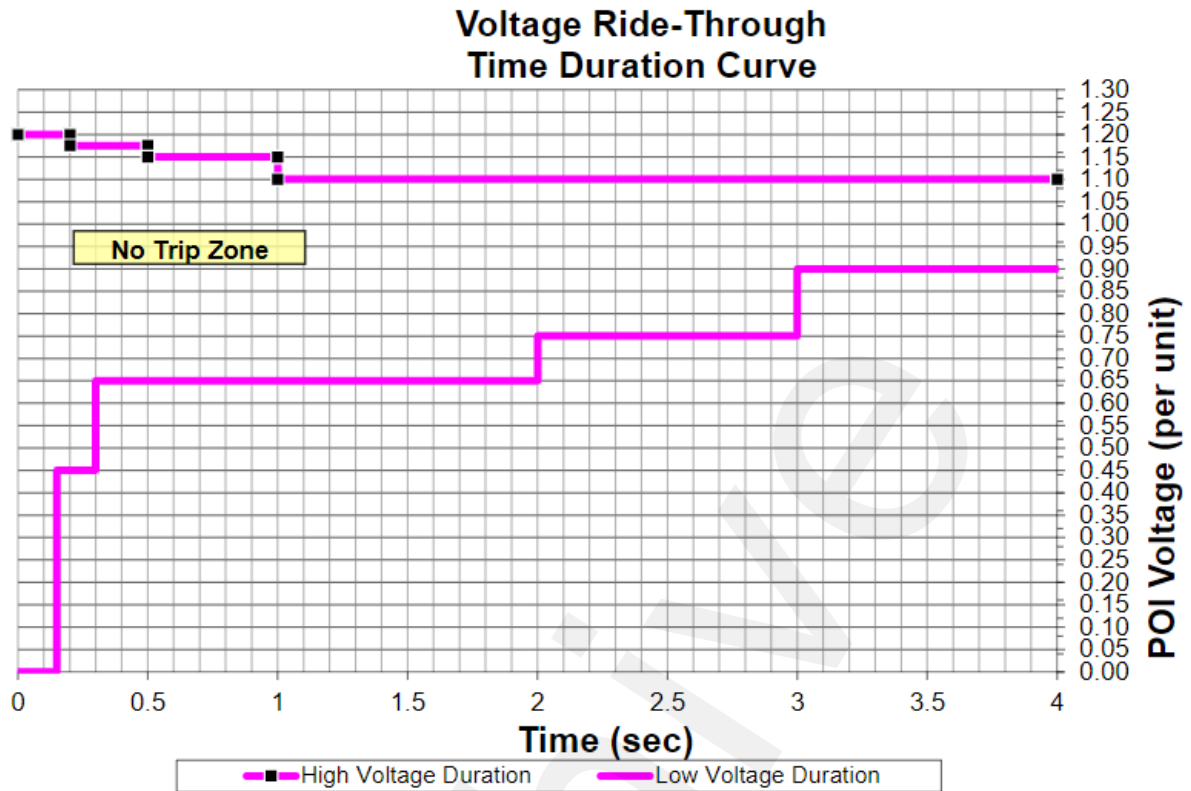

Figure 6 – NERC PRC-024 Voltage Ride Through Requirement

Inverter-based generation and *electricity storage units* shall not reduce current injection at the high – voltage terminal of the main output transformer during routine switching events and design criteria contingencies. Inverter-based *generation units* and *electricity storage units* shall control the type of current needed based on terminal conditions, and respond accordingly to provide a combination of active and reactive current injection (e.g., reactive power priority).

Tripping for contingencies that would disconnect by configuration is permitted. A need to clear faults without intentional delay shall prevail in cases of conflict between a need to clear in-zone faults without intentional delay and a need to ride through out-of-zone faults.

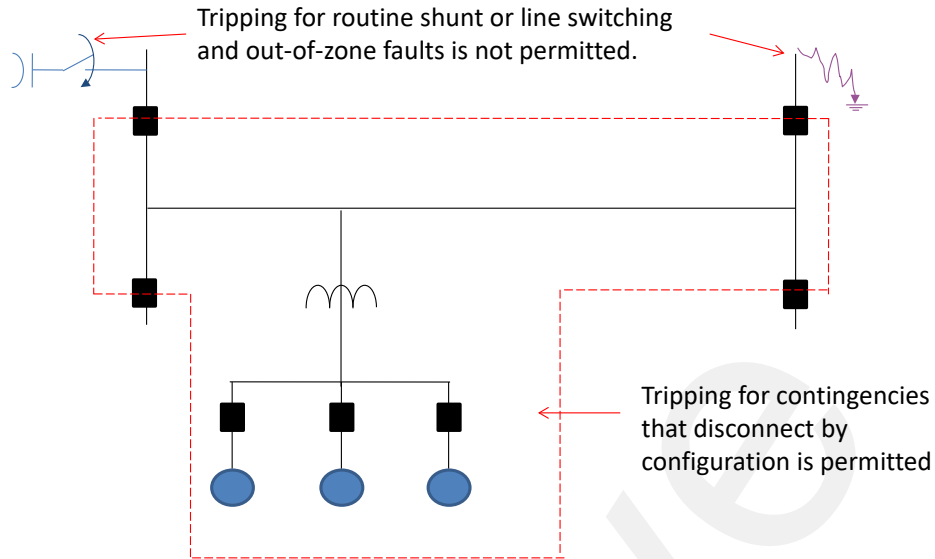

Figure 7 - Single-Line Diagram of No-Tripping for Out-of-Zone Faults Requirement

The standard times below should be used in lieu of site-specific timing.

Voltage Level (kV)	Local Normal Clearing Time (ms)	Local Delayed Clearing Time (ms)	Remote Normal Clearing Time (ms)	Remote Delayed Clearing Time (ms)	Breaker Interrupting Times (ms & cycles)	Breaker Failure 62b Time (ms)
500	66	156	91	181	33 (2)	90
230	83	192	108	217	50 (3)	105
115	116	256	141	281	83 (5)	140

Special consideration may be given in situations where generation or electricity storage trips result from unusually long fault clearing by a *Transmitter* and no material adverse effects to the reliability are anticipated. To ensure a consistent understanding of protection timing, an annotated graph showing waveforms is below.

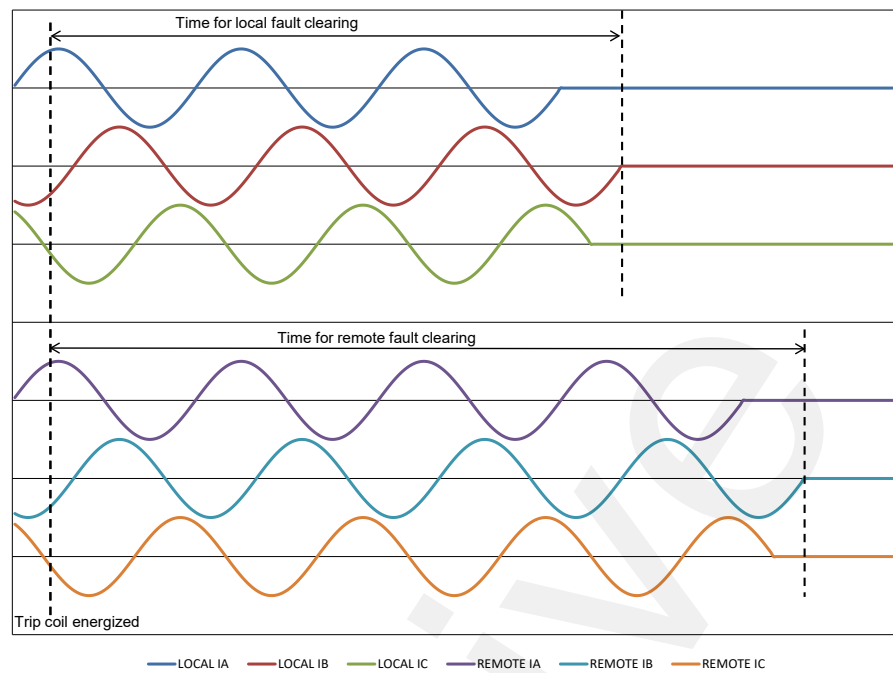

Figure 8 - Example Current Waveform for Showing Fault Clearing Times

Preferably the waveforms should be the input to the protection system, but the outputs of all relevant current transformers is sufficient. As interrupting time can be a function of current level; the times to energize breaker trip coils will often be the most practicable method to validate timing during live zone test trips.

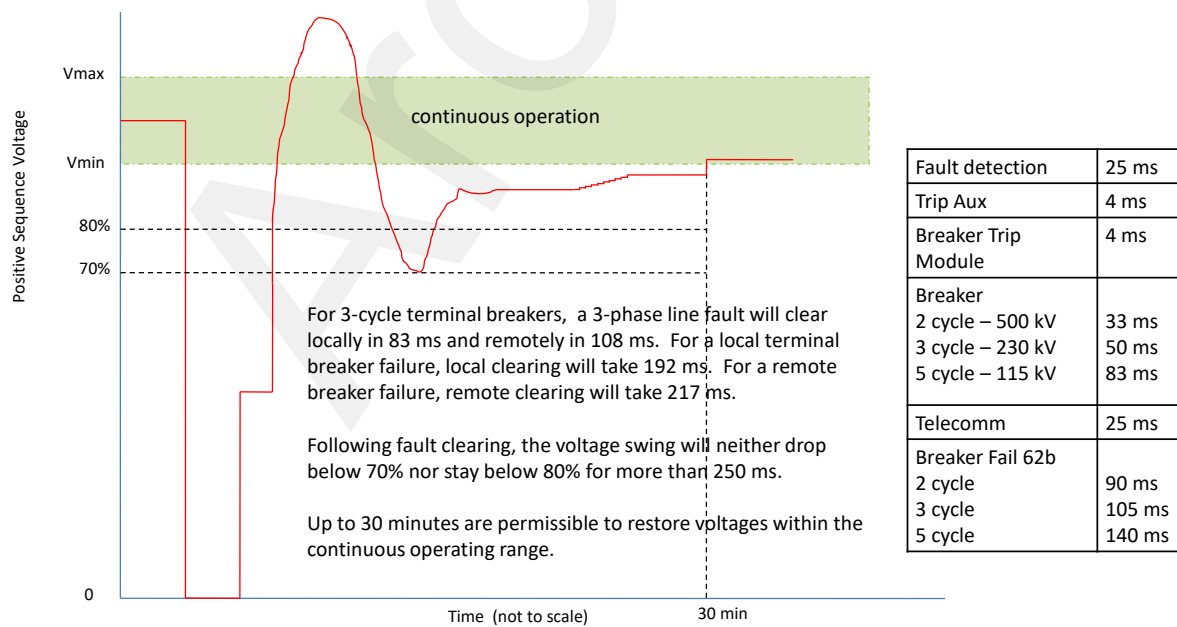

Figure 9 - Positive Sequence Voltage During a Fault

Type tests from an accredited independent testing agency will be accepted as validation of voltage ride through (VRT) capability until reasonable grounds arise to doubt this capability. Tripping for out-of-zone faults or routine switching events are reasonable grounds for doubt.

3.4 Active Power

4. Active Power	Continuously supply all levels of active power output within a +/- 5% range of its rated terminal voltage. Rated active power is the smaller output at either rated ambient conditions (e.g. temperature, head, wind speed, solar radiation) or 90% of rated apparent power. For <i>electricity storage facilities</i> , rated active power values shall be separately specified for both injection and withdrawal operations. To satisfy steady-state reactive power requirements, active power reductions to rated active power are permitted.
-----------------	--

Rated active power (RAP) determines the required magnitude of reactive power. RAP is determined at “design” ambient conditions: for hydro-electric units at a “design” hydro-electric head, for gas units at a “design” ambient temperature, and for wind units at a “design” wind speed and air density. In most cases, this design rating will be only slightly lower than maximum level of active power participation in *IESO* administered markets.

Assumed conditions shall be realistic when determining RAP. It would not be acceptable to rate hydro-electric units with a forebay to tailrace drop of 100 m on the basis of a 10 m head or to rate wind generation on the basis of a low wind speed. Attempting to avoid reactive power obligations by manipulating RAP or reducing nameplate capability is unacceptable to the *IESO*.

Thermal units, in particular, can have materially higher active power output during winter conditions as colder temperatures result in higher air density for gas units and colder cooling water for steam units. RAP for thermal units is typically calculated under summer conditions as reactive concerns are generally more pressing during summer months.

The *IESO* practice for assessing multiple *generation units* and/or *electricity storage units* connected behind the same main output transformer (e.g., wind farms) is to aggregate their active power when calculating the rated active power and, consequently, the reactive power requirements.

Generators and *electricity storage participants* will face restrictions if automatic action, such as those initiated by the continuous settings of the field current limiter, prevents reactive requirements from being satisfied at any active power output level. When manual action must be taken to reduce unit loading, only active power output may be reduced unless *IESO* approves reactive power output changes.

When equipment limitations will prevent reaching the required reactive capability, planned field and stator upgrades must be completed to establish the capability to produce the required reactive power at all levels of active power output. Until these upgrades are completed, active power restrictions may be imposed.

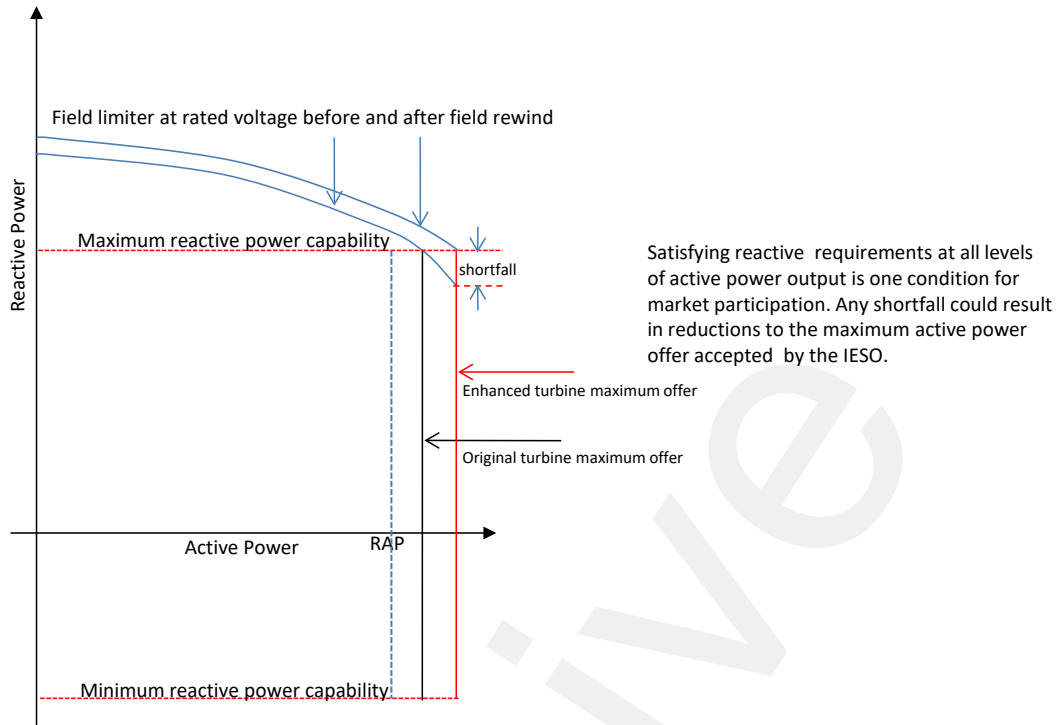

Figure 10 - Reactive Power Requirement at all Levels of Active Power

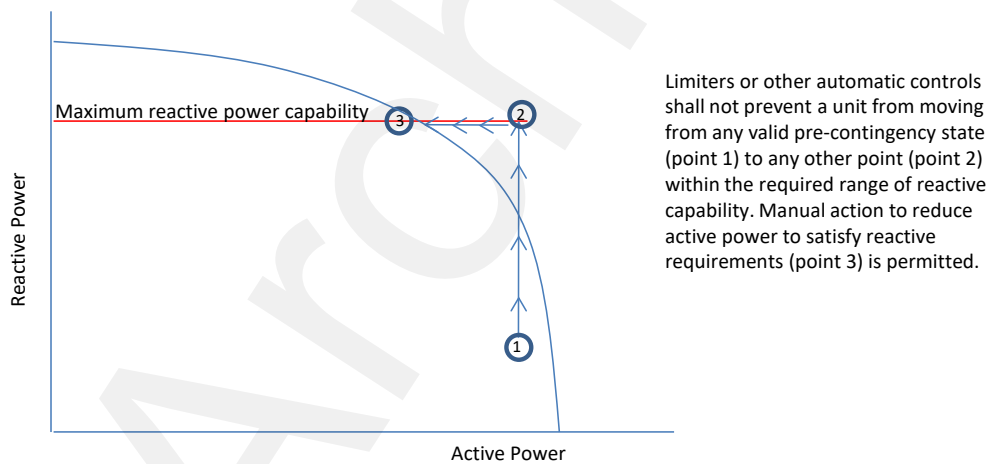

Figure 11 - Reactive Power Priority

There has been a tendency for *generation facilities* to identify forbidden zones of prolonged active power operation following the initial approval to connect. As these forbidden zones can have material effects on operation, proponents should disclose forbidden zones during the connection assessment process.

3.5 Reactive Power

5. Reactive Power	Continuously (i.e., dynamically) inject or withdraw reactive power at the high-voltage terminal of the main output transformer up to 33% of the applicable rated active power at all levels of active power, and at the typical <i>transmission system voltage</i> except where a lesser continually available capability is permitted with the <i>IESO's</i> approval. A conventional synchronous unit with a power factor range of 0.90 lagging and 0.95 leading at rated active power connected via a main output transformer impedance not greater than 13% based on <i>generation unit</i> rated apparent power is acceptable. Reactive power losses or charging between the high-voltage terminal of the main output transformer and the connection point shall be addressed in a manner permitted by IESO approval.
-------------------	---

Performance at the high-voltage side terminal of the main output transformer will be the focus of *IESO* required testing to demonstrate performance. In configurations that either inject or withdraw a material amount of reactive power by configuration, *generation facilities* and *electricity storage facilities* shall have the capability to reduce reactive power transfers to near zero at all times. A typical *transmission system voltage* is the most frequently observed voltage, over the most recent year or more, based on the *IESO* historical data for the specific location.

The capability to inject or withdraw full reactive power at the high-voltage side terminal of the main output transformer (e.g. $Q=RAP/3$) is required at all active power levels and is sketched in Figure 11. It is acceptable for fixed admittance capacitors (shown as V^2B) to compensate for reactive losses within (shown as I^2X in Figure 12) the *generation facilities* or *electricity storage facilities*, as applicable. If fixed admittances are arranged to compensate for reactive losses (e.g. converter, generator transformer, distribution system, main output transformer) at all levels of active power output, then having dynamic capability to inject or withdraw $Q=RAP/3$ at the high-voltage side terminal of the main output transformer of the *generation facility* or *electricity storage facilities* would suffice to meet this requirement.

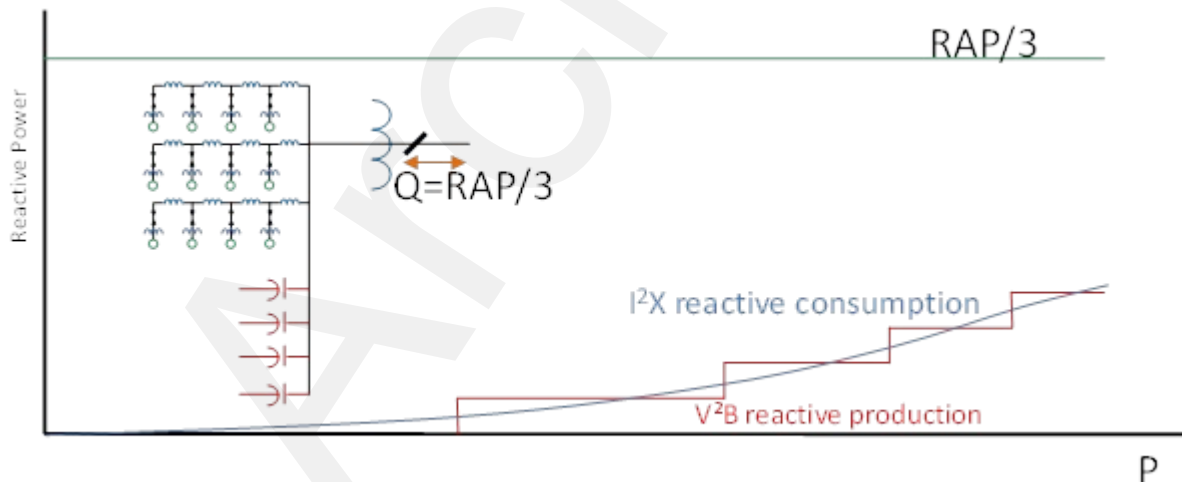

Figure 12 - Fixed Admittance Capacitors Compensating Losses Within Generation Facilities

Unlike the relatively consistent P-Q characteristic for conventional units, P-Q characteristics for non-conventional units vary widely among vendors. The phrase “a lesser continually available capability” provides latitude to the *IESO* to accept designs that provide reactive support during windless (or dark for solar) conditions where this feature is useful. P-Q characteristics with either more reactive capability in useful portions of the characteristic or dynamic reactive capability under windless conditions may be given conditional approval to connect by *IESO*.

Three different voltage control strategies for non-conventional *generation facilities* and inverter based *electricity storage facilities* comprising many relatively small units are listed below:

1. Common Voltage: Raise/lower terminal voltage of each unit equally and allow reactive power and power factor differ from unit to unit,
2. Common Reactive Power: Raise/lower reactive power equally from each unit equally and allow terminal voltage and power factor differ from unit to unit,
3. Common Power Factor: Raise/lower power factor of each unit equally and allow terminal voltage and reactive power differ from unit to unit.

Each of these methods of control can result in units reaching a limitation prior to others depending on their placement along a feeder circuit and active power production. To utilize capability, controls should allow units that have not reached a limit to continue to adjust output to regulate. An example is present below for Common Reactive Power Control for a wind farm.

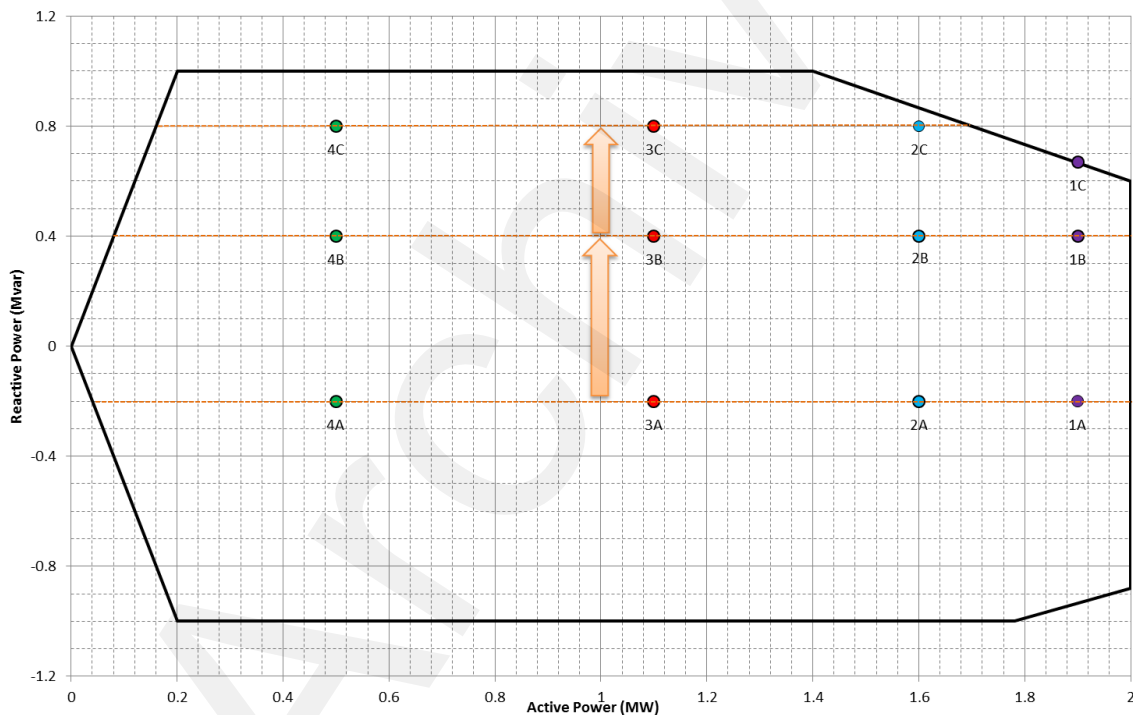

Figure 13 - Regulation with Individual Units at Limit

Figure 13 illustrates an example of four turbines (labeled 1, 2, 3, & 4) connected to the same feeder with different but constant levels of active power production. As reactive demand from the facility increases, the operating points for the four turbines moves from point A to point B to point C. Turbine 1 hitting its reactive limit at operating point 1C should not interfere with other turbines increasing their reactive output beyond this level.

Achieving a well-coordinated dynamic response from equipment supplied by different vendors can be elusive and resolving problems in these circumstances has been a challenge. Designs that require

close coordination across vendors will require measurements from existing installations that demonstrate behaviour acceptable to *IESO* before it grants conditional approval to connect.

3.6 Automatic Voltage Regulator (AVR)

6. Automatic Voltage Regulator (AVR)	Regulate voltage automatically within $\pm 0.5\%$ of any set point within $\pm 5\%$ of rated voltage at the low-voltage terminal of the main output transformer if the transformer impedance is not more than 13% based on the rated apparent power of the <i>generation facility</i> or <i>electricity storage facility</i> , or at a point approved by the <i>IESO</i> . Reactive power-voltage droop or AVR reference load current compensation shall not be enabled without <i>IESO</i> approval. The equivalent time constants shall not be longer than 20 ms for voltage sensing and 10 ms for the forward path to the exciter output.
--------------------------------------	--

For distributed *generation units* and *electricity storage units* controlled by a central system (e.g. wind/solar farm energy management system), the impedance between the voltage reference point and the highest voltage terminal shall not be more than 13%. If the main output transformer impedance is larger than 13%, the capability to control to a reference within the transformer is required. Reference points further into the system than the point of common coupling require special attention to avoid adverse effects on the *generation facility*.

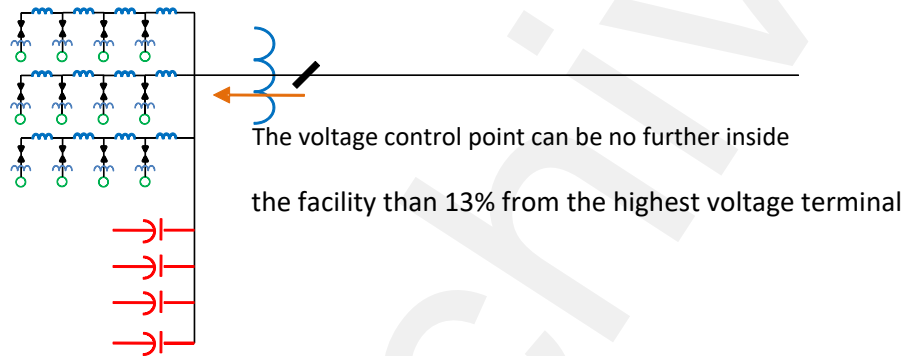

Figure 14 - Voltage Control Point

Controlling voltage at or electrically near the low voltage collector bus has the following advantages for both the proponent and the *IESO*:

- The collector system voltage deviations will be smaller,
- The main output transformer tap will be changed less frequently,
- The isolation provided by the main output transformer will make the automatic voltage regulation system less susceptible to interference from external control systems,
- The confirmation of proper AVR response will be easier, and
- The models used for *IESO* planning and operating purposes will be more accurate.

The requirement to control within $\pm 0.5\%$ of the setpoint would result in a gain of 200 in a proportional AVR control system. With an element of integral gain, the proportional AVR gain can be less than 200 provided other requirements such as voltage response time are satisfied. The voltage reference point must be adjustable to a corresponding distance within the 13% impedance limit where it is desirable to have a reactive droop larger than 0.5%.

Where multiple units are bussed together at a common point, it is necessary to compensate the AVR reference point some impedance away from this common point to achieve balanced sharing of

reactive power requirements. When the unsaturated direct axis reactance is small (e.g. less than 0.5 pu), compensating 10% from the common point may not provide enough separation. In these exceptional cases, impedance compensation of approximately 5% based on the rated unit voltage and apparent power should be construed as meeting the intent of this requirement.

The AVR on/off telemetry status point shall only be set to on when the generator is in voltage control mode. Telemetry to the IESO shall be configured so operation in any other control modes such as power factor control or reactive power control mode shall indicate the AVR is off.

When special configurations arise such as the one shown below, a provision should be made that the AVR voltage source will be the same when one main output transformer is out of service and the normally open low voltage bus tie breaker is closed.

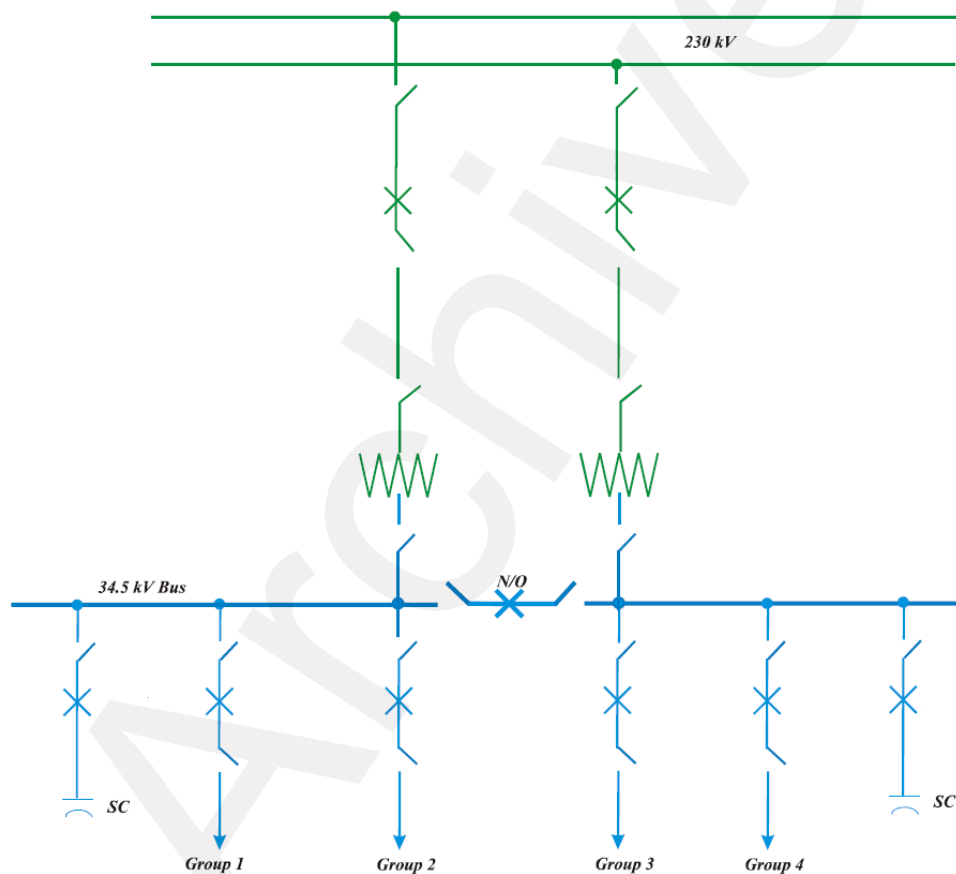

Figure 15 - Example of Configuration Which Requires Two AVR Voltage Sources

3.7 Excitation System

<p>7. Excitation System for Synchronous Machines Greater than 20 MVA or any Synchronous Machines within Facilities Greater than 75 MVA</p>	<p>Provide (a) Positive and negative ceilings not less than 200% and 140% of rated field voltage, respectively while supplying the field winding of the generation unit or <i>electricity storage unit</i> operating at nominal voltage under open circuit conditions; (b) An excitation transformer impedance not greater than 10% on excitation system base; (c) A voltage response time to either ceiling not more than 50 ms for a 5% step change from rated voltage under open-circuit conditions; and (d) A linear response between ceilings.</p>
--	---

Unless otherwise specified by *IESO*, rated active power (RAP) at 0.9 power factor lagging will be used as a basis to calculate “rated” field voltage and current when determining positive and negative excitation system ceilings. Rated field voltage is defined as the product of field current at rated terminal voltage, rated active power and the required maximum continuous reactive power, with the field resistance at nominal operating temperature. The nominal operating temperatures are specified in the [Register Facility Help File](#) as 75 °C for hydro units and 100 °C for thermal units.

The base field current of a *generation unit* or *electricity storage unit* produces rated terminal voltage along the open circuit air gap line. The unitbase field voltage and base field current are related by field resistance at a specified temperature (100°C round-rotor, 75°C salient-pole) unless *IESO* accepts other temperatures. Time constants for conventional machines should be given at the specified temperatures. Time constants for non-conventional machines shall be valid for ambient conditions at RAP.

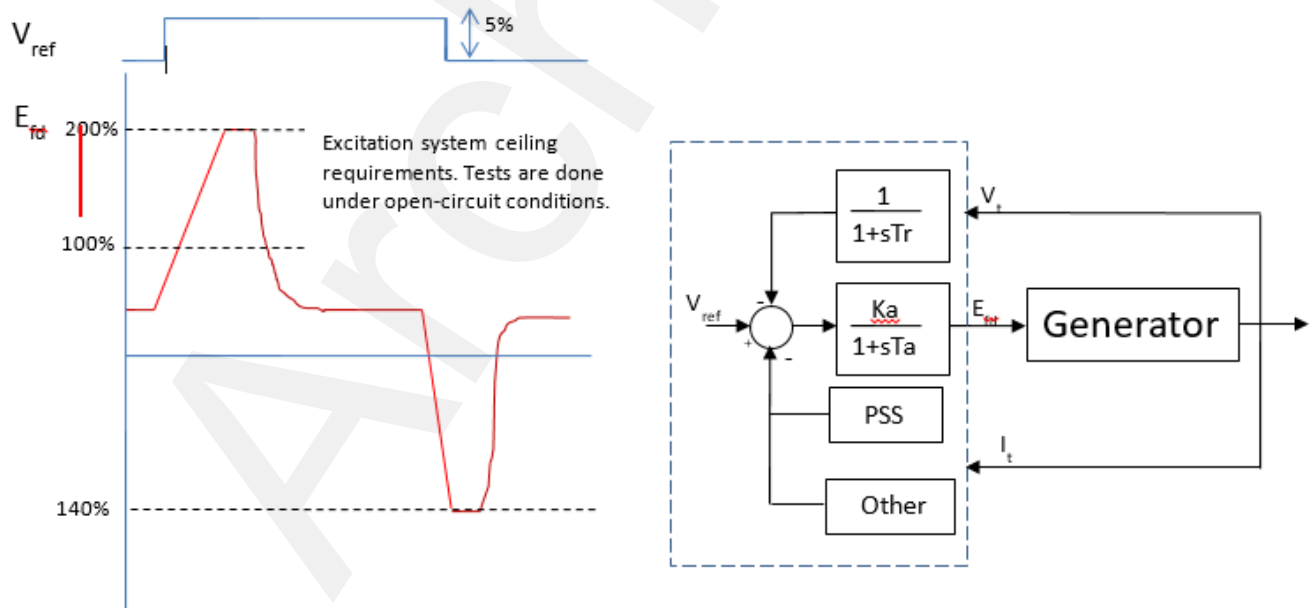

Figure 16 - Excitation System Ceiling Requirements

3.8 Power System Stabilizer (PSS)

<p>8. Power System Stabilizer (PSS) for Synchronous Machines greater than 20 MVA or any Synchronous Machines within Facilities Greater than 75 MVA</p>	<p>Provide (a) A change of power and speed input configuration; (b) Positive and negative output limits not less than $\pm 5\%$ of rated AVR voltage; (c) Phase compensation adjustable to limit angle error to within 30° between 0.2 Hz and 2.0 Hz under conditions specified by the IESO, and (d) Gain adjustable up to an amount that either increases the damping ratio above 0.1 or elicits poorly damped exciter modes of oscillation at maximum active power output unless otherwise specified by the IESO. Due consideration will be given to inherent limitations.</p> <p>For <i>electricity storage units</i>, Power System Stabilizer shall be disabled while withdrawing.</p>
--	---

Active power electro-mechanical oscillations of equipment connected to the *IESO-controlled grid* must be well damped. This requirement is directed at types of *generation units* and *electricity storage units* prone to poorly damped electro-mechanical oscillations when equipped with high performance exciters. Other types of generation (e.g. non-synchronized solar or wind) that will not exhibit poorly damped active power oscillations will not require a stabilizer. For electro-mechanical active power oscillations observed at the connection point, the damping ratio must exceed 0.03 in steady state, exceed zero in response to a contingency, and exceed 0.01 following all automatic actions after a contingency. Within 30 minutes, *IESO* will direct operations to restore a damping ratio of 0.03 for electro-mechanical active power oscillations.

IESO will discriminate between electro-mechanical active power oscillations that could result in material adverse effects on the power system and mechanical active power oscillations that will not result in material adverse effects. Active power oscillation from either the ‘3P’ effect arising from air flow restrictions caused by wind turbine towers or scroll case/runner imbalance in hydro-electric units are examples of sources of mechanical oscillations that cause sustained active power fluctuations that are not electro-mechanical in nature and therefore not subject to *IESO*’s damping requirements.

Experience has shown stabilizer designs that do not directly measure or calculate rotor speed are not as robust for changing system conditions such as transmission outages. For this reason, only designs that enable a $\Delta P\omega$ (power and rotor angle speed) configuration will be approved by *IESO* during the connection assessment process. Estimating rotor angle speed with a combination of terminal voltage, terminal current, and ‘q’ axis impedance is acceptable to *IESO*.

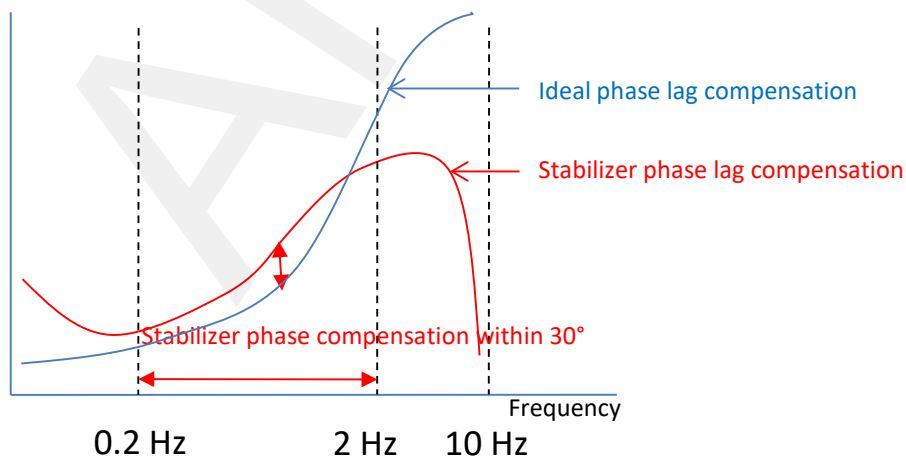

Figure 17 - Power System Stabilizer Phase Compensation Margin

The stabilizer activation level will normally be set at about 15% of full power to avoid needless voltage excursions when starting, stopping, and loading units. The stabilizer deactivation level will normally be set at about 10% of full active power. This hysteresis between activation and deactivation levels mitigates the risk of chatter. The phrase “due consideration will be given to inherent limitations” was intended to allow for reasonable practices. For example, hydro-electric units with a wide mechanical power ‘rough zone’ will benefit from a turn-on level at the high end of this ‘rough zone’. Adequate damping will be required at permissible steady operating points below this turn-on level.

Where *IESO* identifies a relatively low risk of island operation, a higher level of stabilizer output (e.g. 10%) may be employed when it provides a material advantage. The requirement to have the stabilizer output ceiling not less than $\pm 5\%$ was intended to mitigate adverse effects during island operation while still enabling a good level of response during interconnected operation.

Onerous post-contingency configurations will be used by *IESO* as the basis for tuning stabilizer settings. *IESO* will identify these onerous configurations and provide connection point characteristics to assist stabilizer tuning.

3.9 Phase Unbalance

9. Phase Unbalance	Provide an open circuit phase voltage unbalance not more than 1% and operate continuously with a phase voltage unbalance as high as 2% at the high-voltage terminal of its main output transformer.
--------------------	---

Generation units and *electricity storage units* are required to be well balanced and to be able to operate continuously in the presence of some imbalance. Equipment that is not well balanced will not be permitted to remain connected to the *IESO-controlled grid*. For example, facility owners must remove units from service when the output from the excitation bridge is not well balanced.

During the market entry process, the balance will be measured at the unit terminals and excitation bridge output for conventional synchronous units. For non-conventional units, balance will be measured at the high-voltage side terminal of the main output transformer when a single well-defined terminal is not present.

Phase unbalance may be calculated using either of the following IEEE definitions:

$$phase\ unbalance = \frac{\max(V_{an} - V_{avg}, V_{bn} - V_{avg}, V_{cn} - V_{avg})}{V_{avg}}, V_{avg} = \frac{V_{an} + V_{bn} + V_{cn}}{3}$$

$$phase\ unbalance = \left| \frac{V_{neg\ seq}}{V_{pos\ seq}} \right|$$

The calculated phase unbalance must be below the threshold using at least one of these equations.

3.10 Armature and Field Limiters

10. Armature and Field Limiters	Provide short-time capabilities specified in IEEE/ANSI 50.13 and continuous capability determined by either maximum field current, maximum stator current, core-end heating, or minimum field current. More restrictive limiting functions, such as steady state stability limiters, shall not be enabled without <i>IESO</i> approval.
---------------------------------	---

The intent of this requirement is to avoid material adverse effects on reliability or market efficiency from undue restrictions in the capability to sustain temporary high levels of armature and field current. The ANSI/IEEE 50.13 standard is applicable to round-rotor machines, but in lieu of better information this requirement will also be applied to salient-pole machines. These temporary levels from the present standard are tabulated below.

Time (s)	Armature Current (% of rated)	Field Current (% of rated)
10	218	209†
30	150	146
60	127	125
120	115	113

†May be as low as 160% to coordinate with the excitation system performance requirements

Margins for practical considerations such as measurement and metering errors and discrete time steps for limiters shall keep kept as small as reasonably achievable.

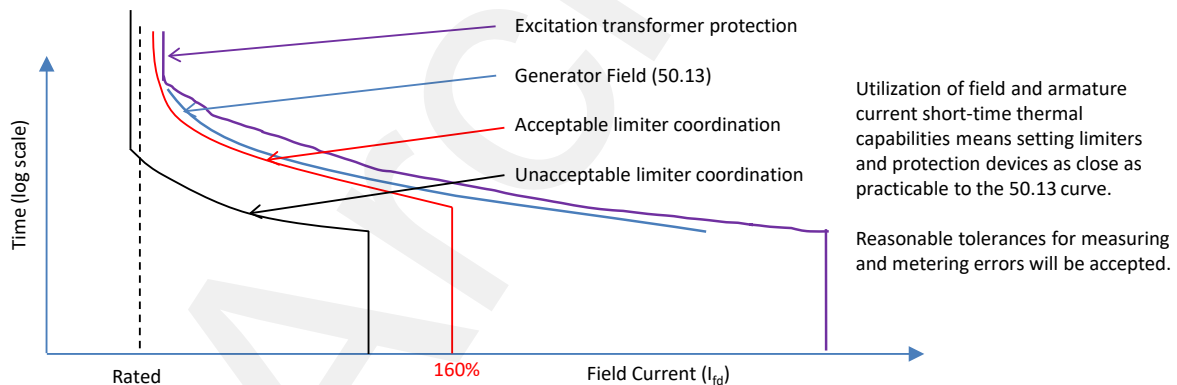

Figure 18 - Temporary Field Current Requirements

Limiters and protection settings shall be translated onto both a time dependent field current characteristic (shown above) and a steady state capability curve (shown below) in the test report to demonstrate the required coordination has been achieved. Field current limiters should not interfere with the delivery of required reactive power at any active power output level.

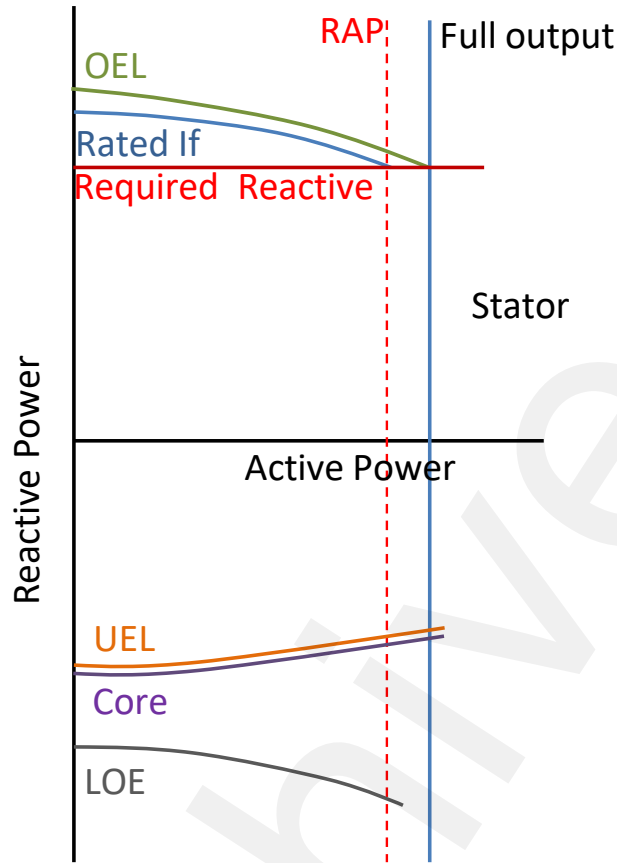

Figure 19 - Capability Curve

The armature and field limiter requirement will be deemed to have been satisfied for non-conventional forms of generation and electricity storage as long as connection point performance is at least as good as a conforming synchronous unit.

Limiter settings may become a critical consideration when upgrading active power (e.g. hydro-electric runner replacement) output levels and should be given due attention during the connection assessment process.

3.11 Technical Characteristics

11. Technical Characteristics	Exhibit, at the high-voltage terminal of its main output transformer, performance comparable to an equivalent synchronous <i>generation unit</i> with characteristic parameters within typical ranges. Inertia, unsaturated transient impedance, transient time constants, and saturation coefficients shall be within typical ranges (e.g. $H > 1.2$ Aero-derivative, $H > 1.2$ Hydroelectric less than 20 MVA, $H > 2.0$ Hydroelectric 20 MVA or larger, $H > 4.0$ Other synchronous units, $X'd < 0.5$, $T'do > 2.0$, and $S1.2 < 0.5$) except where permitted by the <i>IESO</i> approval.
-------------------------------	---

There is often some uncertainty surrounding machine characteristics before equipment purchases are finalized. *IESO* may assess proposals using conservative characteristics that meet “Market Rules” performance requirements. When acceptable performance cannot be achieved with conservative characteristics, the proponent will be consulted to determine whether they can commit to providing better performance characteristics. For example, if an aero-derivative generating unit requires an inertia value of 1.4 s for reliable performance at the highest desired level of market participation and the proponent commits to this value, then full participation may not be authorized unless performance tests confirm this higher inertia value. In general, connection assessment conditions for approval to connect will be based on the best performance characteristics that a proponent can commit to provide.

For combined cycle plants, the inertia requirement $H > 4$ is intended to apply to a facility as a whole. As a first pass, inertia should be calculated on a facility basis as follows

$$H_{eq} = \frac{\sum_{i=1}^n S_{base_i} * H_i}{\sum_{i=1}^n S_{base_i}}$$

The inertia requirement for facilities will allow leeway for rounding. For example, an equivalent inertia value for a combined cycle plant of 3.6 will be construed as meeting the requirement.

When committed equipment characteristics taken as a whole provide overall performance as good as from characteristics that marginally meet “Market Rules” requirements and will reliably allow the desired level of market participation; the phrase “except where permitted by the *IESO*” provides latitude for reasonable accommodations. Performance as good as will be interpreted by *IESO* as allowing the same level or higher levels of transfers.

All equipment connected to the *IESO-controlled grid* shall conform to *good utility practice*. Unless specifically informed otherwise, *IESO* will assume equipment will conform to legitimate North American standards except when this would be inconsistent with a specific *IESO* performance requirement.

3.12 Reactive Power Response for Inverter-Based Units

12. Reactive Power Response to Voltage Changes of Inverter-Based Units	For a constant voltage at the high-voltage terminal of the main output transformer, achieve a sustained reactive power change of 30% of <i>generation facility or electricity storage facility</i> rated apparent power at the low-voltage terminal of the main output transformer within 3s following a step change no larger than 4% to the AVR voltage reference. AVR response to the voltage error signal must be consistent over the entire operating range.
--	---

During reactive power response testing, a 2% step change to the AVR reference voltage will be applied to evaluate the reactive power response of inverter-based facilities. A sustained reactive power change of 15% of the rated apparent power of a *generation facility* or an *electricity storage facility* shall be achievable within 1.5 seconds measured at the low-voltage terminal of the main output transformer. An illustrative sketch of an acceptable vs nonacceptable reactive power performance is shown in Figure 20.

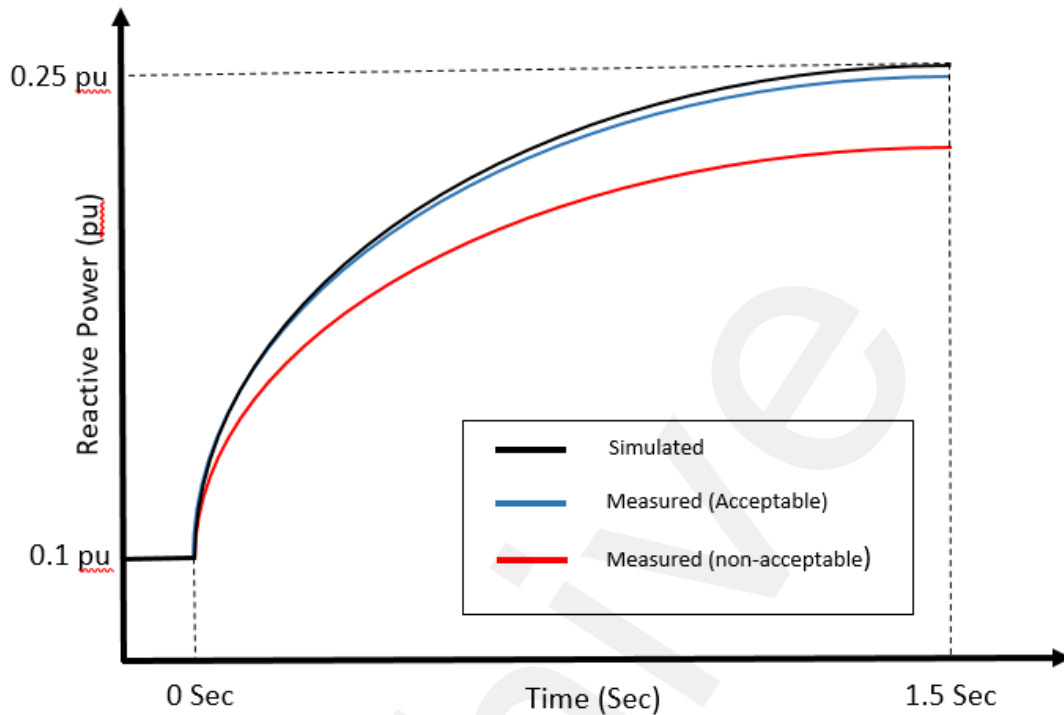

Figure 20 – Acceptable vs unacceptable reactive power response of Inverter-based units

3.13 Electricity Storage

The Appendix 4.2 principle for comparing alternative technologies to a conforming synchronous machine with equal apparent power rating to determine whether a requirement is satisfied will also be applied when evaluating the performance of *electricity storage units* directly connected to the *IESO-controlled grid (ICG)*.

Electricity storage units directly connected to the *ICG* must satisfy the applicable performance requirements in Appendix 4.2 while injecting and withdrawing.

Any *electricity storage unit* connected to the *distribution system* or *wholesale customer facilities* must satisfy the performance requirements 1, 2 and 3 in Appendix 4.2, as described in requirement 12 of Appendix 4.3 while injecting and withdrawing.

Due considerations will be given to inherent limitations (e.g. withdrawal using squirrel-cage induction machines, or injection using synchronous machines) during the *Connection Assessment* process or performance validation process.

- End of Section -

4. Validation of Other Elements

The primary object of this section is to identify for *Market Participants* validation requirements and assessment considerations for new or modified connections to the *IESO-controlled grid*. Anticipated testing requirements by equipment category are summarized in Section 5.4.

4.1 General

Design parameters used in assessments may not exactly match “as-built” characteristics and this difference may materially affect *IESO* operating and planning decisions. For example, the impedance tolerance for two-winding transformers is $\pm 7.5\%$ while for autotransformers, zigzag transformers, or transformers having three or more windings the tolerance is $\pm 10\%$. It may be prudent to use impedance at the bottom end of tolerance to establish short-circuit capabilities and to use impedance at the top end of tolerance to establish reactive power capabilities and stability limits.

Proponents must demonstrate “as-built” equipment satisfies connection requirements and equipment models are valid. Operating telemetry will usually provide a check of factory test results or calculated design values. Checks may also be provided from available on-site measurements that are more accurate than operating telemetry. Confirming “as-built” equipment in some cases may be as simple as confirming nameplate values are provided during facility registration. In other cases, operating telemetry will be used to confirm model parameters.

Factory tests performed on factory assembled equipment (e.g. transformers) will be the primary method to validate equipment characteristics with on-site telemetry providing a check. On-site telemetry for field assembled equipment (e.g. cap banks, transmission circuits) will be the primary method to validate equipment characteristics with factory tests providing a check. Material differences between operating telemetry and *IESO* state estimation will prompt a review of the steady state representation of equipment with asset owners.

4.2 Switches and Breakers

Maximum continuous operating ratings and interrupting times will be confirmed from nameplate or facility registration information after installation.

4.3 Transmission Circuits

Standard powerflow parameters (e.g. R, X, B) must be validated with operating telemetry after installation.

4.4 Series Compensation

Standard powerflow parameters (e.g. series X) must be validated with operating telemetry after installation.

4.5 Shunt Compensation

The standard powerflow parameter (e.g. shunt B) and synchronous closing unit timing, if applicable, must be validated with operating telemetry after installation.

4.6 Transformers

Standard powerflow parameters (e.g. impedance, turns ratio) from factory tests must be validated with operating telemetry after installation. Tap one shall be the maximum turns ratio to conform to the CSA standard. For phase shifting transformers installed in Ontario on tie lines to neighbouring jurisdictions, tapping down (e.g. moving from tap 2 to tap 1) shall tend to move active power out of the *IESO-controlled grid*. For voltage regulating transformers installed in Ontario on tie lines to neighbouring jurisdictions, tapping down (e.g. moving from tap 2 to tap 1) shall tend to move reactive power out of Ontario.

4.7 Synchronous Condensers and Static var Compensators (SVC)

Reactive power capability, speed of response, and the suitability of models and parameters for planning and operating studies must be validated by measurements after installation.

4.8 Protection Systems

The timing between fault initiation and fault clearing must be validated by measurements after installation. Usually the time between event initiation and energization of breaker trip coils will be sufficient. Satellite clock synchronization of timing is required when the protection zone extends between stations (e.g. transmission circuits).

4.9 Special Protection Systems (SPS)

A Functional Description Document (FDD) provided to the *IESO* must describe initiating events and responses (see Figure 18) as well as the sequence and timing of events (see Figure 22). The FDD must also describe any interlocks that could interfere with the operation of the SPS.

An SPS must have Northeast Power Coordinating Council (NPCC) approval prior to deployment. Although the *IESO* will take responsibility for having the type of an SPS (e.g. Type 1, Type 2, or Type 3) determined by NPCC's Task Force on System Studies; assistance from the proponent will be required. The design of a Type 1 or Type 2 SPS must be reviewed by NPCC's Task Force on System Protection. Further assistance from a proponent will be required during this review. The design review can be a lengthy process.

To provide greater clarity, a functional example of implementing required SPS actions either to detect configuration changes or to initiate trips in relation to a breaker-trip module is shown in Figure 22.

An orderly matrix approach to organizing input triggers and output actions has been found to have several advantages: it tends to simplify the validation process; it lends itself to *IESO* operational

requirements; it avoids introducing the status of out-of-service elements into logic for input triggers; and it also lends itself to future expansion should this need arise.

An SPS must be triggered by contingencies unless otherwise approved by the *IESO*. To improve speed of response and robustness, the contingency detection logic should include triggers from breaker trip modules as well as the breaker pallet switches. An acceptance functional example of SPS contingency detection logic is shown below.

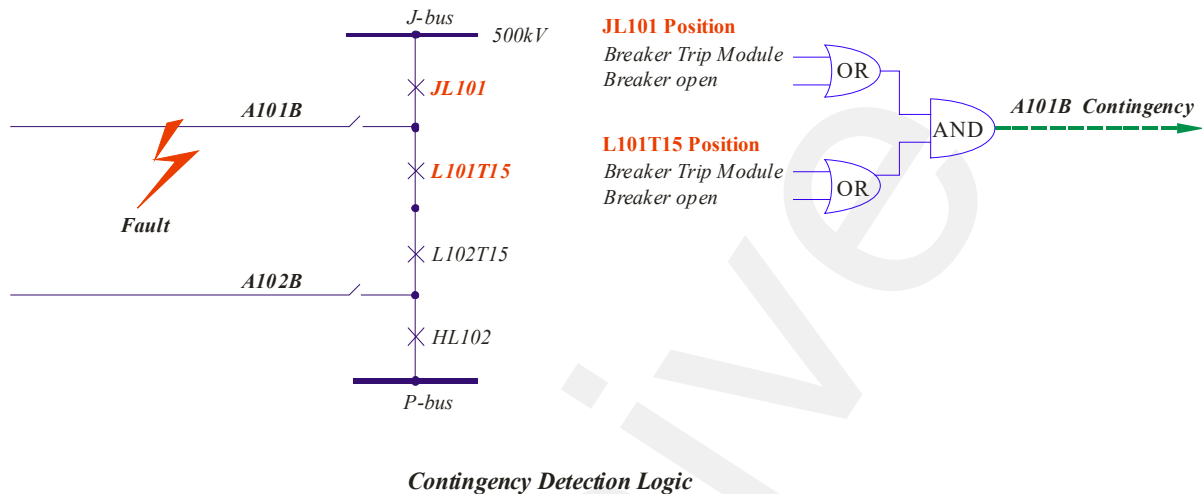

Figure 21 - Contingency Detection Logic

The consequences of an SPS breaker failing to operate when called upon are evaluated by *IESO*. To mitigate the risk of cascading outages, breaker failure shall not initiate further breaker failure protection in adjacent protection zones on the *IESO-controlled grid*. Examples of acceptable arrangements for generation rejection are shown in Figure 23.

Provisions for generation runback or generation rejection or both shall be made at new generation facilities. Generation runback is preferred to rejection when it suits reliability requirements. When runback is subject to a common mode failure, the redundant protection must both sense when runback is not working as intended and initiate generation rejection. For example, when non-redundant wind farm energy management systems implement runback, redundant protection must reject generation should the wind farm energy management system fail to runback generation as required. Acceptable arrangements for generation runback are shown in Figure 24.

Functionality and timing will be required to be tested before a SPS is deployed. The time following contingency detection to completion of the desired SPS action will be required to be measured for each protection group. To the extent practicable, testing shall be end-to-end. *IESO* may approve tests that sub-divide the chain of events when end-to-end tests have material adverse effects on reliability. An illustration of an SPS timing sequence is shown in Figure 25.

Telecommunication considerations for protection systems require particular attention. Leased facilities from telecommunication companies may not meet “Transmission System Code” performance requirements for protection systems or provide acceptable path diversity to satisfy NPCC requirements. Proponents will be expected to work closely with *Transmitters* to design, install, and maintain suitable facilities.

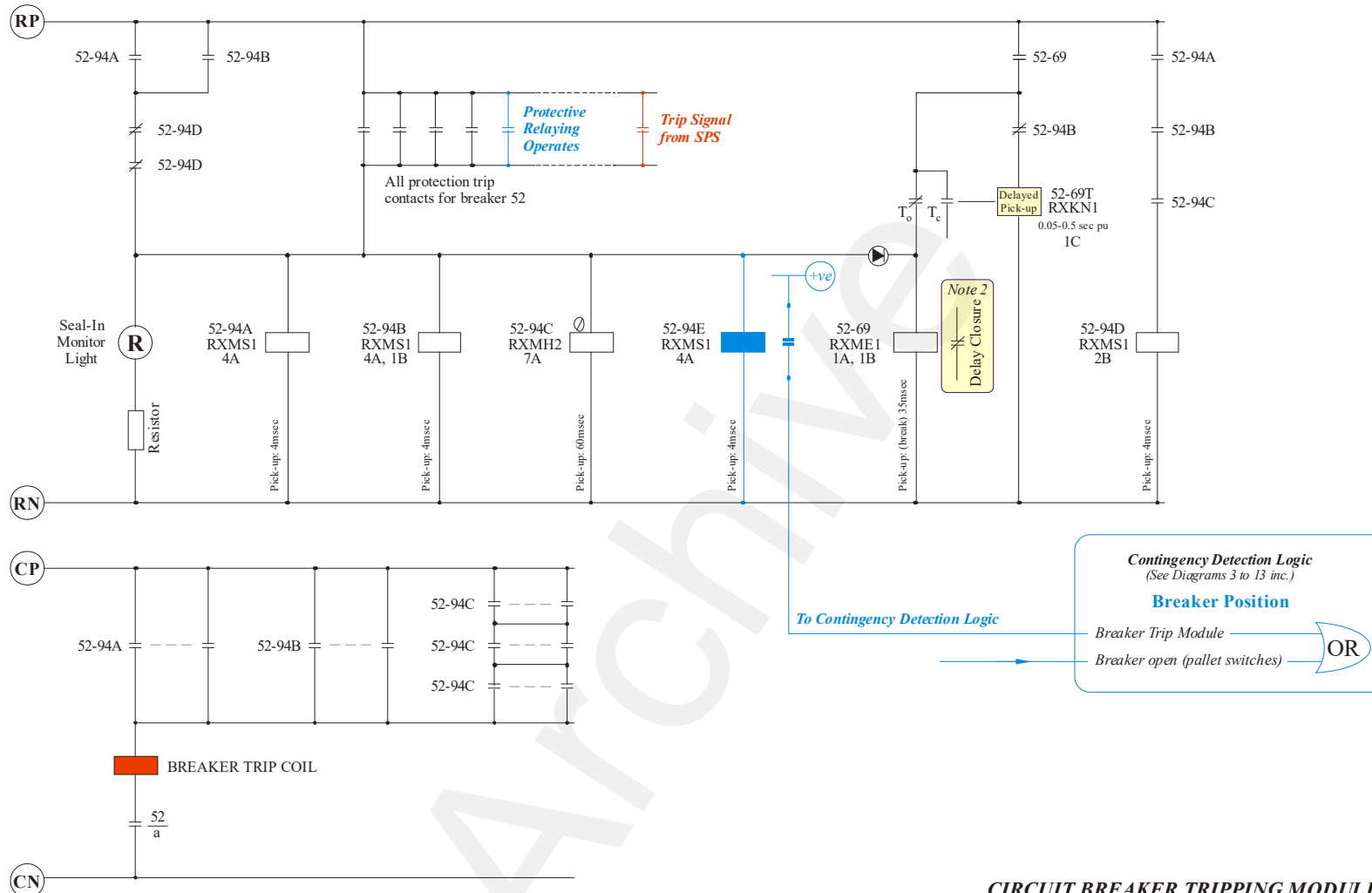

CIRCUIT BREAKER TRIPPING MODULE REQUIREMENTS

The circuit breaker tripping module should perform the following functions:

1. Protect the high speed tripping auxiliary relay contacts from damage due to interrupting circuit breaker trip coil currents;
2. Prevent closing of the circuit breaker while the trip module is energised, and for a definite time after the trip signal is removed, ensure that the timing relays in the breaker failure circuits have reset before the circuit breaker can be closed.

CIRCUIT BREAKER TRIPPING MODULE

[Annotated Generic Version of the Diagram]

DIAGRAM 2

8th April 2010

Figure 22 - Breaker Trip Module

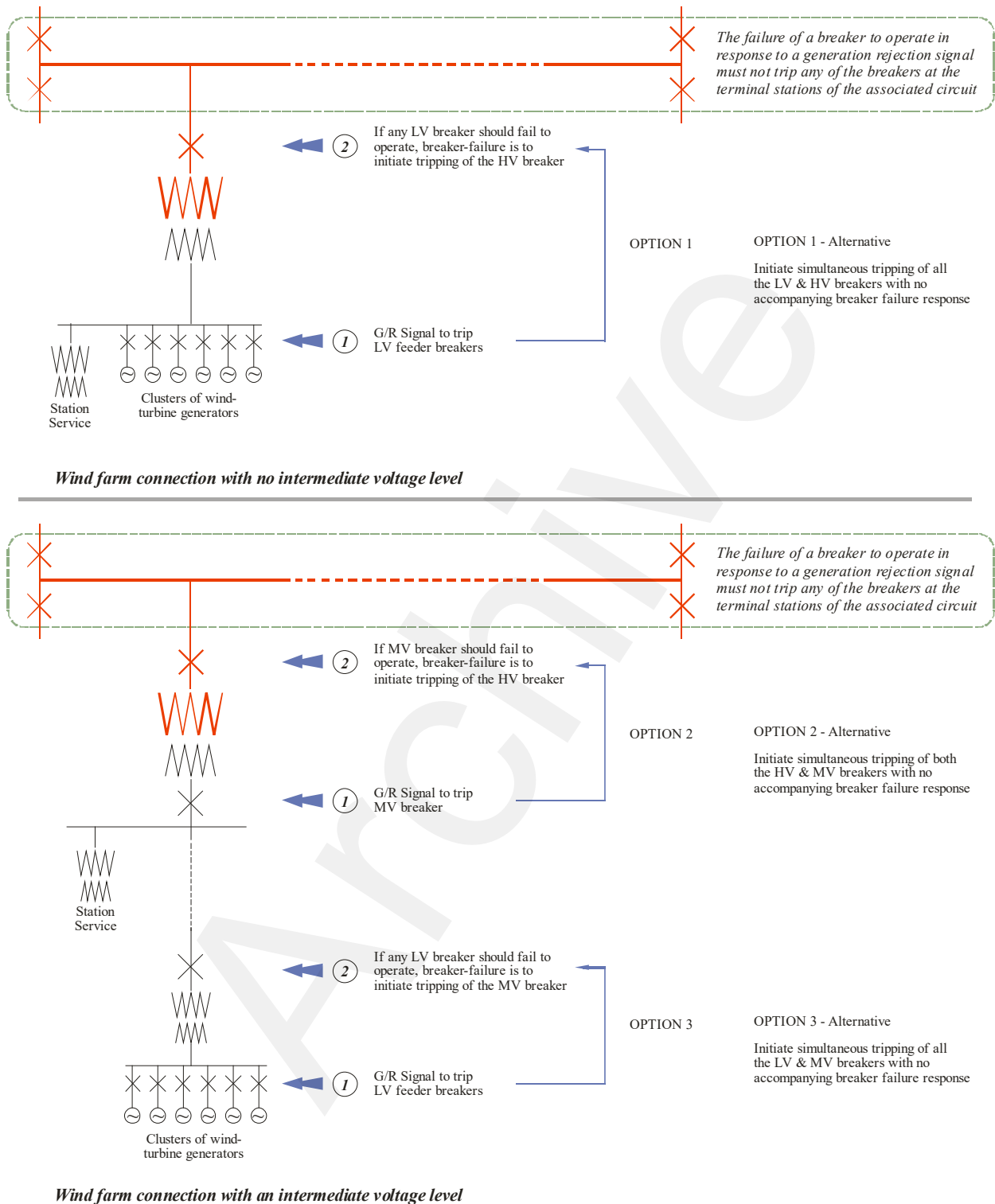

Typical Connection Arrangements for Wind Farms with suggested generation rejection responses

DIAGRAM 3
23rd September 2009

Figure 23 - Generation Rejection

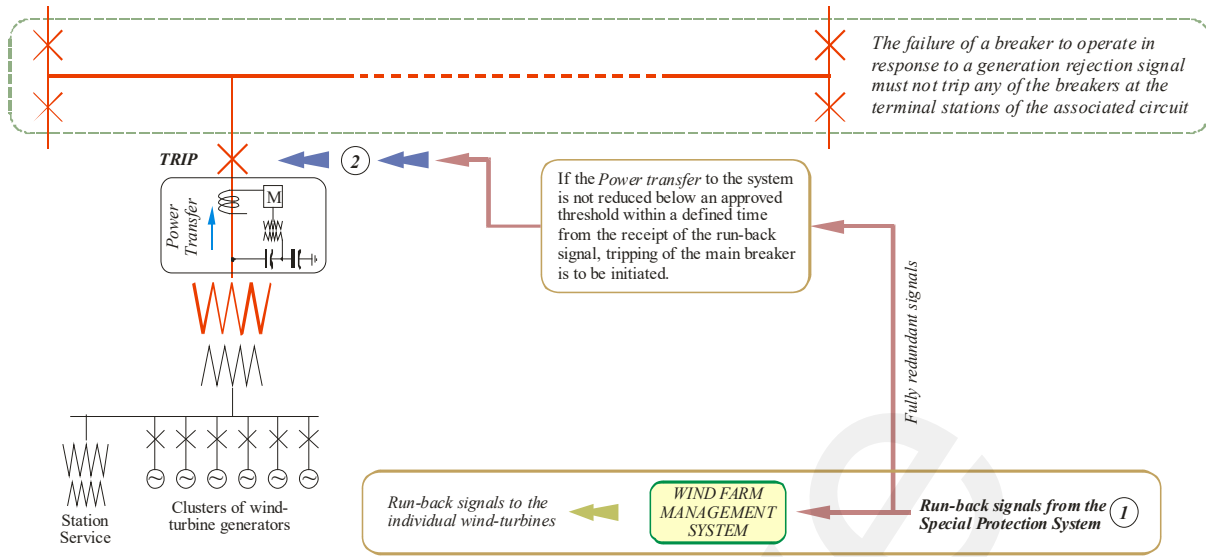

Wind farm connection with no intermediate voltage level

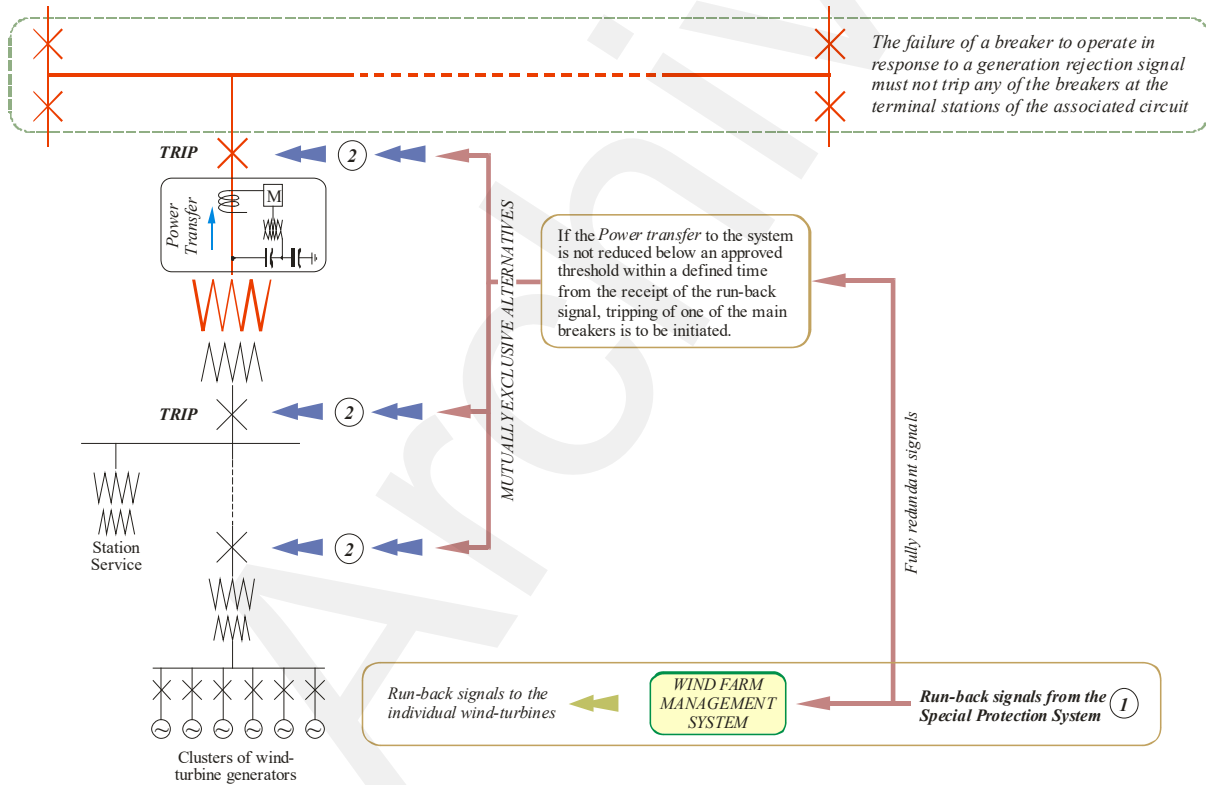

Wind farm connection with an intermediate voltage level

Typical Connection Arrangements for Wind Farms with suggested generation run-back responses

DIAGRAM 4

7th April 2010

Figure 24 - Generation Runback

HEARN SPS: Typical Operating Times		
CONTINGENCY CONDITIONS DETECTED AT HEARN SS		Σ
REJECT/INITIATE RUN-BACK OF THE PORTLANDS UNITS		88ms
CONTINGENCY CONDITIONS DETECTED AT LEASIDE TS		
REJECT/INITIATE RUN-BACK OF THE PORTLANDS UNITS		106ms
CONTINGENCY CONDITIONS DETECTED AT CECIL TS		
REJECT/INITIATE RUN-BACK OF THE PORTLANDS UNITS		112ms 106ms
CONTINGENCY CONDITIONS DETECTED AT ESPLANADE TS		
REJECT/INITIATE RUN-BACK OF THE PORTLANDS UNITS		106ms
CROSS-TRIP TERAULEY CIRCUIT-SWITCHERS		138ms

- 25ms
PR Primary Relaying
- 4ms
AR Auxiliary Relay
- 4ms
TM Trip Module
- 12ms
SPS SPS Matrix
- 33ms (For a 2-cycle breaker)
BT Breaker Trip Time

If a breaker-failure condition were addressed by the Scheme then a further 90ms would need to be added to the contingency detection time [corresponds to a 62b timer]

DIAGRAM 5
11th April 2010

Figure 25 - Protection Timing

- End of Section -

5. Testing, Reporting, and Modelling

The primary objects of this section are to assist proponents in developing a scope of validation tests and prepare the corresponding reports for efficient passage through the market entry process. A secondary object is to summarize relationships between performance requirements and testing to assist proponents. The section on default modelling is intended primarily for *IESO* staff performing assessments or those providing model parameters for these assessments.

5.1 Conventional Generation and Non-Inverter Based Electricity Storage Facilities Reporting Requirements

General

A validation report will comprise three main elements: a description of the tests and calculations in enough detail to for the *IESO* to properly interpret testing results, the ratings and the models derived from observations and measurements, and test results. Test measurements shall also be submitted in an electronic format (e.g. CSV) acceptable to the *IESO*. The use of simulation models to demonstrate the validity of other models will not satisfy *IESO*.

For both steady state and dynamic model parameters, model predictions shall be superimposed on measurements to assist validation. In the descriptions below, black font indicates a setting, a rating, a calculated value, or other vendor provided information, red font indicates measurements, and blue indicates a typical range or boundary conditions for the test. The infinity symbol is used to denote steady states values (e.g. OEL_{∞} , is the steady state over-excitation limiter setting). An indication is provided where only measured results are required.

It is acceptable to verify dynamic performance for some protective functions (e.g. V/Hz, OEL, UEL) by temporarily revising settings into a range that assists performance verification.

If tests do not show requirements are satisfied, the *IESO* will either modify its approval for a facility to remain connected or revoke its approval for a facility to connect. In general, active power participation level will be tailored to match measured performance with respect to requirements.

Description and Ratings

Machine Characteristics: MVA_{base} , V_{base} , MCR, RAP, PF, RPM, $I_{fd_{rated}}$, $R_{fd@^{\circ}C}$, E_{fdbase} , I_{fbase}

Excitation Transformer: MVA_{base} , V_{prim} , V_{sec} , leakage reactance

Characteristics

Open Circuit Curve: rated V_t and I_{fd} , air gap line, measured V_t/I_{fd} , vendor V_t/I_{fd}

Rotating Exciters: rated V_{ex} and I_{ex} , measured V_{ex}/I_{ex} , vendor V_{ex} , I_{ex}

Capability Curve: RAP, MCR, rated stator current, rated field current, OEL_{∞} , end heating limit, LOE, UEL_{∞} . Current shall be represented on the capability curve at rated voltage.

Field Current I_t curve: OEL, ANSI C50.13, excitation transformer

Underfrequency Curve: As left settings against requirement

Measurements (and simulations with models and parameters provided)

Steady State: P , Q , V_t , $I_{fd}/(I_{fd_{calculated}})$, Gate or Speed Reference, Rotor Angle

Partial Load Rejection: Hz, P - 10-25% MW

Zero Power Factor Leading Load Rejection: V_t , E_{fg} , I_{fg} , P , Q - 0 MW, 15-25% Mvar, AVR in manual

Governor Dynamic Response: P , Gate

Turbine Gate vs Power curve: P , Gate

Governor Droop: Speed ref/ P or Gate/ P

Governor Ambient: Hz, P , deadband (long time measurement)

Open Circuit Perturbations: V_t , freq, P , Q , I_{fd} , E_{fd} - $\pm\Delta 2\%$ AVR reference steps

Open Circuit Ceilings: V_t , freq, P , Q , I_{fd} , E_{fd} - $\pm\Delta 5\%$ AVR reference steps

Open Circuit Fuse Pull: V_t , freq, P , Q , I_{fd} , E_{fd} (measured only)

PSS Phase Compensation: frequency, phase shift, calculated required phase shift

PSS Step Response: V_t , freq, I_{fg} , E_{fg} , P , Q , $K_s \sim 0$, $K_s = \text{final}$, $K_s = 2 * \text{final}$ (or $\zeta > 0.1$)

V/Hz Test: V_t , V/Hz, freq (measured only) - open circuit, 97% governor setpoint, reduced V/Hz limit

OEL: V_t , freq, P , Q , I_{fd} , E_{fd} (measured only)

UEL: V_t , freq, P , Q , I_{fd} , E_{fd} (measured only)

Open Circuit Terminal Voltage Balance: V_{ab} , V_{bc} , V_{ca} or V_0 , V_1 , V_2 (measured only)

Protection and Limiter Settings

As left settings: U/F, V/Hz, OEL, LOE, OOS, impedance backup, voltage restrained overcurrent, reverse power, negative sequence current (I_2^2t). On a periodic basis, settings shall be submitted in accordance with the IESO workbooks to demonstrate compliance with NERC PRC-019, PRC-024, and PRC-025 and IESO requirements.

5.2 Non-Conventional Generation and Inverter-Based Electricity Storage Facilities Reporting Requirements

General

A validation report for a non-conventional facility has the same objects as a corresponding report for a conventional facility. The diverse nature of non-conventional generation facilities makes it necessary to specify a more general approach to testing than for conventional facilities. Test measurements shall also be submitted in an electronic format (e.g. CSV) acceptable to the *IESO*.

Collector System Parameters

Collector system parameters will be verified by submitting active power, reactive power and voltage simultaneously at each unit as well as the active power, reactive power and voltage at the low voltage winding of the main output transformer for two instances in time, typically near 0% and 100% of rated active power. **V, P, Q.**

Voltage Control

The voltage control point shall be demonstrated to be no further than 13% ($V_{c13\%}$) based on the facility rated apparent power from a connection point. Unless otherwise specified, this connection point shall be taken as the high voltage disconnect of the main output transformer. The position of the measured voltage and current (V_m, I_m) as well as the amount of compensation (X_{comp}) shall be provided to make this determination.

$$V_{control} = V_m + jX_{comp}I_m < 13\% \text{ from connection point}$$

Voltage regulation must be as good as provided by a conventional synchronous machine behind an impedance of 13%. It is acceptable to compensate for reactive droop with voltage control location. For example, with a 4% reactive droop the voltage control point can be no further than 9% from the connection point. **V_{control}, V_m, I_m, X_{comp}.**

Steady State Reactive Power Capability

Steady state reactive power injection and withdrawal will be tested. For both reactive injection and withdrawal, stopping criteria is outlined in the *NERC MOD-25* workbook. **V_{c13%}, P, Q.**

Dynamic Reactive Capability

Measurements at 25%, 50%, 75%, and 100% full active power or at other levels acceptable to the *IESO* shall demonstrate the required dynamic capability. At each active power level, the sum of injected reactive power and spare dynamic reactive capability shall be more than $P_{max}/3$. **V, P, Q.**

Dynamic Active Power Response

The active power response to frequency events and plant MW reference changes will be tested as outlined in the *NERC MOD-27* workbook. The speed of active power response from no-load to full-load and from full-load to no-load may be measured to inform operating practices. The sequence of events following loss of connection may also be verified. **V, P, Q, f, ambient conditions**

Dynamic Reactive Power Response

A measurement shall be provided at any output level acceptable to the *IESO* that demonstrates both the speed and magnitude of reactive power response is comparable to an equivalent size synchronous machine and active power damping is acceptable. The perturbation can be either a voltage reference step change or shunt element switching as outlined in the *NERC MOD-26* workbook. **V, P, Q.**

If tests do not show requirements are satisfied, the *IESO* will either modify its approval for a facility to remain connected or revoke its approval for a facility to connect. In general, active power participation level will be tailored to match measured performance with respect to requirements. The following two examples are intended to illustrate this approach:

- If the required steady state-reactive capability range requirement is ± 30 Mvar for a desired maximum level of active power participation, but performance validation tests demonstrate only a capability of ± 15 Mvar. In this case, performance would only justify an active power participation level of 50% of the desired maximum.
- Dynamic reactive response will be assessed by comparing the area under the reactive power-time curve of the equivalent size synchronous machine with the measured results as shown in Figure 24. In this case, the ratio of the areas $A_{wf1}:A_{sync1}$ would be used to determine the active power participation level.

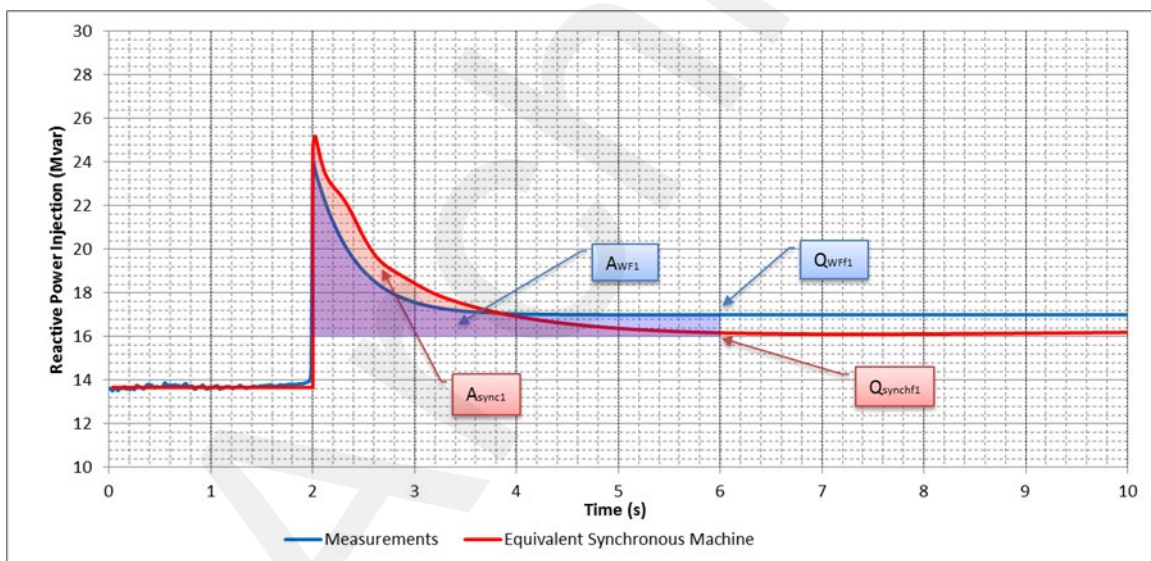

Figure 26 - Active Power Participation Justified by Performance

Voltage and Frequency Settings

On a periodic basis, settings shall be submitted in accordance with the *IESO* workbook to demonstrate compliance with *NERC PRC-024*, and *IESO* requirements.

5.3 Summary of Generation and Electricity Storage Facilities Considerations and Tests

Category	Connection Assessment Considerations	Standard Tests – see Section 3
	<i>Generation facility or electricity storage facility directly connected to the IESO-controlled grid shall have the capability to:</i>	
1. Off-Nominal Frequency Operation	Describe “no-trip” above the line not “must-trip” below the line rationale.	Settings on a frequency-time curve
2. Speed/Frequency Regulation	Describe how requirements apply to this facility as a whole if applicable. Describe requirement to automatically change settings for island detection when this is required for stable operation (e.g. hydro-electric units). Provide island setting frequency trigger. Describe inherent limitations for the particular application.	Speed Reference/ droop test Ambient condition deadband test Speed of response test Power/Gate/Flow characteristic Island mode frequency trigger setting reported
3. Voltage Ride Through	Describe rationale for both low voltage (LVRT) and high voltage (HVRT) ride through. HVRT requirements should be identified in conjunction with the associated transmitter. Identify tripping for routine switching events and design contingencies that do not disconnect by configuration is unacceptable.	Type tests for LVRT Connection point measurements for HVRT PT fuse failure AVR switchover Settings of V/Hz, LOE, voltage restrained o/c, and other protection that “sees” into the system
4. Active Power	Describe that active power is expected over a range of system conditions. Identify forbidden zones.	Tabulate steady state P, Q, Vt, Ifd, and rotor angle from minimum to maximum active power
5. Reactive Power	Identify <i>connection point</i> , steady-state and dynamic reactive requirements based on RAP.	Capability curve with RAP, MCR, LOE, UEL, OEL, rated field current indicated
6. Automatic Voltage Regulator (AVR)	Describe acceptable voltage control point, gain (droop), and time delay requirements.	Open circuit voltage perturbation <5% Reactive perturbation for AVR droop
7. Excitation System for Synchronous Machines Greater than 20 MVA or any Synchronous Machines within Facilities Greater than 75 MVA	Describe ceilings, linearity, and speed requirements.	Open circuit and loaded perturbation tests Excitation Transformer MVA, leakage reactance to establish rectifier regulation factor
8. Power System Stabilizer (PSS) for Synchronous Machines Greater than 20 MVA or any Synchronous Machines within Facilities Greater than 75 MVA	Identify ΔP_{ω} configuration, output limits, phase compensation, and gain requirements. Assess risk of island vis-à-vis $\pm 5\%$ ceiling limit. Identify and assess most onerous damping situation.	Phase compensation plot Damping with $K \sim 0$, $K = \text{final}$, $K = 2 * \text{final}$ at full power. On/off activation levels, confirm ΔP_{ω} configuration
9. Phase Unbalance	Describe the required power quality and tolerance requirements.	Open circuit voltage balance
10. Armature and Field Limiters	Describe acceptable limiter and protection infringements on capability and the link between active power and reactive power limitations, Describe requirement for excitation system not to infringe on 50.13 short time capability.	Steady state limiter settings on capability curve Field IT curve with excitation transformer, 50.13, protection, and OEL settings OEL/UEL reduced setting test I_2^2t settings
11. Technical Characteristics	Describe equivalent synchronous machine concept and its application for the particular connection. Ensure time constants match rated field temperature. Conformance with widely recognized North American standards.	Open circuit saturation curve Partial load rejection or type test
12. Reactive Power Response to Voltage Changes of Inverter-Based Units	For a constant voltage at the high-voltage terminal of the main output transformer, achieve a sustained reactive power change of 30% of generation facility rated apparent power at the low-voltage terminal of the main output transformer within 3s	As described in requirement

Category	Connection Assessment Considerations	Standard Tests – see Section 3
	<i>Generation facility or electricity storage facility directly connected to the IESO-controlled grid shall have the capability to:</i>	
1. Off-Nominal Frequency Operation	Describe “no-trip” above the line not “must-trip” below the line rationale.	Settings on a frequency-time curve
	following a step change no larger than 4% to the AVR voltage reference. AVR response to the voltage error signal must be consistent over the entire operating range.	

5.4 Summary of Other Equipment Considerations and Tests

Equipment	Connection Assessment Considerations	Standard Tests – see Section 4
Switches and Breakers	Describe required maximum voltage and current. Describe making and breaking current requirements for shunts. Describe synchronizing breaker requirements. Describe autoreclosure requirements.	Provide “as-built” values of maximum operating voltage and interrupting time. No additional on-site tests will be required.
Transformers	Describe required tap convention (i.e. 1 is max ratio). Describe LTC and fix tap range requirements. Describe impedance used in the assessment. Account for parameter uncertainty. Describe power flow convention for tie line phase shifters and voltage regulators.	Provide “as-built” values for powerflow parameters (e.g. impedance, tap turns ratio), Confirm tap one is maximum turns ratio. Compare operating telemetry with state estimated* V, P, Q
Shunt Compensation	Describe $\Delta V < 4\%$ requirements for switching to be done a minimum fault level. Account for parameter uncertainty.	Provide “as-built” value of maximum operating voltage and reactance. Confirm switching phase discrepancy error for synchronous closing unit is within tolerance. Compare operating telemetry with state estimated Q, V when first energized
Series Compensation	Account for parameter uncertainty in the assessment.	Provide “as-built” value of reactance. Compare operating telemetry with state estimated P, Q, V at both terminals to confirm series B.
Transmission Circuits	Account for parameter uncertainty. R, X, B, and thermal ratings in the assessment.	Compare operating telemetry with state estimated Q, V when first energized to confirm shunt B. Compare operating telemetry and state estimated P, Q, V at both terminals to confirm series R and X.
Protection Systems	Describe assessed sequence and timing. Describe requirement to provide function description. Identify whether bulk or not bulk criteria apply.	Provide timing from event initiation to energization of breaker trip coils for zone test trip Confirm reach and timing is consistent with assessment requirements.
Special Protection Systems	Identify functional requirements and timing. Identify required NPCC design type. Identify required documentation.	Provide timing for representative events. Provide functional description documentation.
Static var Compensators	Identify minimum acceptable performance	Provide speed of response from field tests. Provide reactive ceilings from field tests.
HVdc and FACTS devices	Identify minimum acceptable performance.	As necessary to validate performance requirements (to be determined on a site-by-site basis).

*In this table, all comparisons with state estimation will be done by the IESO.

5.5 Default Modelling

Default model and parameters that will yield performance that would meet “Market Rules” criteria are listed in this section. Simpler standard models that lead to good operating and planning decisions are preferred to more complex standard models. Experience has shown many drawbacks to user-defined models so their use is permitted only in special circumstances.

Table 1 - Default Power Flow and Dynamics Parameters

	Solar	Wind	Hydro-electric	Gas	Steam
Powerflow	$Q_T = P_{RAP}/3$, $Q_B = -P_{RAP}/3$, $X_T = 13\%$ if generator model comprises main transformer				
Dynamics	Simple†	Simple†	GENSAE EXST1 PSS2A	GENROE EXST1 PSS2A	GENROE EXST1 PSS2A

† A simple model that conservatively predicts performance should be assumed in simulations before validation is performed unless a more complicated model is required to achieve the desired transfer level.

Table 2 - Default Machine Parameters

	T'do	T''do	T'qo	T''qo	H	D	Xd	Xq	X'd	X'q	X''	Xl	S1.0	S1.2
GENROE	6.0	0.02	0.40	0.04	4.0	0.0	2.3	2.3	0.50	1.0	0.25	0.10	0.10	0.50
GENSAE	6.0	0.02		0.04	2.0	0.0	1.5	1.0	0.50		0.35	0.15	0.10	0.50

Time constants at standard field temperatures (e.g. 100°C round-rotor, 75°C salient-pole). Unsaturated reactances.

Table 3 - Default AVR/Exciter Parameters

EXST1	Tr	Vimax	Vimin	Tc	Tb	Ka	Ta	Vrmax	Vrmin	Kc	Kf	Tf
	0.0	999	-999	1.0	1.0	200*	0.01	6.25†	-4.3†	0.08	0.0	1.0

*Gain could be lower with PI AVR control

† Assuming rated field voltage is 3 per unit

Table 4 - Default PSS Parameters

PSS2A‡	IC1	Bus	IC2	M	N	Tw1	Tw2	T6	Tw3	T4	T7	Ks2	KS3	T8
	1	0	3	5	1	10	10	0	10	0.0	10	T7/2H	1	0.5
	T9	KS1	T1	T2	T3	T4	Vmax	Vmin						
	0.1	10	0.07	0.02	0.07	0.02	0.05	-0.05						

‡ Stabilizer parameters are not tuned to either the GENROU or GENSAL and EXST1 default models

The turbine and governor should be modelled when necessary to reduce market participation restrictions.

5.6 Acceptable Dynamic Models

Models acceptable to *IESO* are tabulated below; these are all standard models. Standard models are compatible with *IESO* software tools and mitigate other risks associated with user-defined models. User-defined and non-standard models will be accepted only when standard models will not lead to suitable *IESO* operating and planning decisions. The list of models acceptable to the *IESO* tabulated below is applicable to new submissions only (e.g., commissioning of new or modified equipment test report, *NERC* MOD-026 submission, *NERC* MOD-027 submission, etc.). Parameters and block diagrams for acceptable models are available upon request from *IESO*.

Generator Models

PSS/E Name	Description	Comment
GENSAE	Salient Pole Generator (Exponential Saturation on Both Axes)	
GENROE	Round Rotor Generator (Exponential Saturation)	
GENTPJ	Salient Pole and Round Rotor (Exponential Saturation)	Saturation can be made dependent on stator current to enhance model accuracy over a wide range of operation

Compensator Models

PSS/E Name	Description	Comment
COMP	Voltage Regulator Current Compensating	
COMPCC	Cross Compound Compensating	
IEEEVC	Voltage Regulator Current Compensating	

Power System Stabilizer Models

PSS/E Name	Description	Comment
PSS2A	IEEE 421.5 1992 PSS2A IEEE Dual-Input Stabilizer	
PSS2B	IEEE 421.5 2005 PSS2B IEEE Dual-Input Stabilizer Model	
PSS2C	IEEE 421.5 2016 PSS2C1 IEEE Dual-Input Stabilizer Model	
PSS3B	IEEE Std. 421.5 2005 PSS3B IEEE Dual-Input Stabilizer	
PSS4B	IEEE Std. 421.5 2005 PSS4B IEEE Dual-Input Stabilizer	
IEE2ST	IEEE Stabilizer With Dual-Input Signals	

Excitation System Models

PSS/E Name	Description	Comment
AC7B	IEEE 421.5 2005 AC7B excitation system	Retrofits only
AC8B	IEEE 421.5 2005 AC8B excitation system	Retrofits only
ESAC1A	1992 IEEE type AC1A excitation system l	Retrofits only
AC6A	IEEE Std 421.5 Type AC6A	
ESAC8B	Basler DECS model	
ESDC1A	1992 IEEE type DC1A excitation system	Retrofits only
ESDC2A	1992 IEEE type DC2A excitation system	Retrofits only
DC4B	IEEE 421.5 2005 DC4B excitation system	Retrofits only
ESST1A	1992 IEEE type ST1A excitation system	
ESST4B	IEEE type ST4B potential or compounded source exciter	
EXST1	1981 IEEE type ST1 excitation system	
IEEET2	1968 IEEE type 2 excitation system	Retrofits only
IEEET4	1968 IEEE type 4 excitation system	Retrofits only
IEEEX1	1979 IEEE type 1 excitation system and 1981 IEEE type DC1	Retrofits only
IEEEX2	1979 IEEE type 2 excitation system	Retrofits only
ST5B	IEEE 421.5 2005 ST5B excitation system	
ST6B	IEEE 421.5 2005 ST6B excitation system	
ST7B	IEEE 421.5 2005 ST7B Excitation System	
URST5T	IEEE proposed type ST5B excitation system	

In general, only static excitation systems will satisfy IESO performance requirements for new installations.

Turbine/Governor Models

PSS/E Name	Description	Comment
IEEEG1	IEEE Type 1 Speed-Governing	
IEEEG3	IEEE Type 3 Speed-Governing	
GGOV1	GE General Governor/Turbine	
GGOV1DU	GE General Governor/Turbine with Dead-band	
HYG0V	Hydro Turbine-Governor	
HYG0VD	Hydro Turbine-Governor with Dead-band	
H6E1	Hydro Turbine with American Governor Company Controller	
TGOV1	Steam Turbine-Governor	
WEHGOV	Woodward Electric Hydro Governor	
WSHYDD	WECC double derivative hydro governor	
WPIDHY	Woodward PID hydro turbine governor	

Wind Turbine and Photovoltaic Models

PSS/E (DSA)Name	Description	Comment
REGCA1 (REGC_A)	Renewable Energy Generator/Converter	
REECA1 (REEC_A)	Generic Renewable Electrical Control Model	
REECC1 (REEC_C)	Electrical Control for Utility Scale Battery Energy Storage	
WTDTA1 (WTGT_A)	Generic Drive Train for Type 3 and Type 4 Wind Machines	
WTARA1 (WTGAR_A)	Generic Aerodynamic for Type 3 Wind Machine	
WTPTA1 (WTGPT_A)	Generic Pitch Control for Type 3 Wind Machines	
WTTQA1 (WTGTRQ_A)	Generic Torque controller for Type 3 Wind Machines	
REPCTA1 (REPC_A)	Generic Renewable Plant Control Model – Type 3	
REPCA1 (REPC_A)	Generic Renewable Plant Control Model – Type 4	
REAX3BU1 (REPC_B)	Renewable Energy Auxiliary Control for type 3 wind turbines	To be used with PLNTBU1
REAX4BU1 (REPC_B)	Renewable Energy Auxiliary Control for type 4 wind turbines and PV inverters	To be used with PLNTBU1

Please consult with IESO staff to confirm when torque, pitch, aero, or drive train models are required.

Plant Models

PSS/E Name	Description	Comment
PLNTBU1 (REBC_B)	Generic Plant Control	To be used when plant controller controls multiple different types of assets such as wind turbines, PV inverters, SVC, and/or STATCOM. To be used with REAX3BU1, REAX4BU1, FCTAXBUI, and/or SVCAXBUI.

STATCOM Models

PSS/E Name	Description	Comment
SVSMO3U2	WECC VSC-based Static var System	Control over mechanical switched shunts
CSTATT	Static condenser FACTS	No control over mechanical switched shunts

SVC Models

PSS/E Name	Description	Comment
CHSVCT	SVC for switched shunt	
PSS/E Name	Description	Comment
CSSCST	SVC for switched shunt	
CSVGN1	SCR controlled static var source	
CSVGN3	SCR controlled static var source	
CSVGN4	SCR controlled static var source	
CSVGN5	WECC controlled static var source	
CSVGN6	WECC controlled static var source 1	
SVSMO1U2	WECC Generic Continuous Control SVC	
SVSMO2U2	WECC Generic Discrete Control SVC	
SVCAXBU1	SVC device Auxiliary Control	To be used with PLNTBU1

5.7 Abbreviations and Acronyms

AVR	Automatic Voltage Regulator
CT	Current Transformer
FCR	Field Current Regulator
ICG	<i>IESO-controlled Grid</i>
LOE	Loss of Excitation
MEL	Minimum Excitation Limiter
MCR	Maximum Continuous Rating
MOT	Main Output Transformer
OEL/UEL	Over/Under Excitation Limiter
PF	Power Factor
PSS	Power System Stabilize
PT	Potential Transformer
RAP	Rated Active Power
FDD	Facility Description Document
Efd	Field Voltage
Freq	Frequency
I	Current
Iex	Exciter Current

Ifd	Field Current
Hz	Hertz, Frequency
LOE	Loss of Excitation
OOS	Out of Step
P	Active Power
Q	Reactive Power
Rfd	Field Resistance
RPM	Revolutions per Minute
Sex	Excitation Transformer Rated Apparent Power
Sbase	Rated Apparent Power Base
V	Voltage
Vex	Exciter Voltage
Vpri	Primary Voltage
Vsec	Secondary Voltage
Vt	Terminal Voltage
X_{∞}	Steady State value of X

– End of Document –